



Grown...to meet challenges

INSTRUCTION MANUAL

CASPER

Capacitance Level Limit Switch

Version 1.2

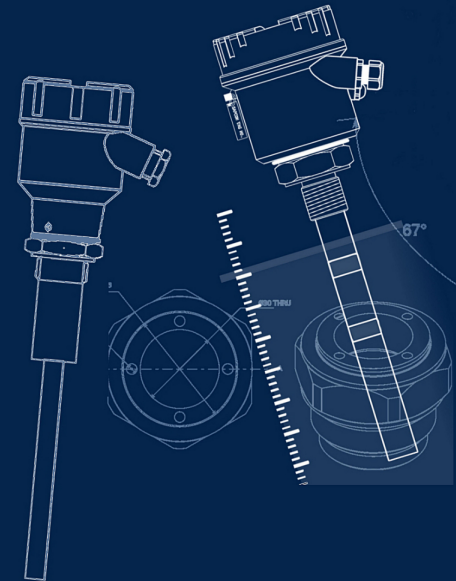
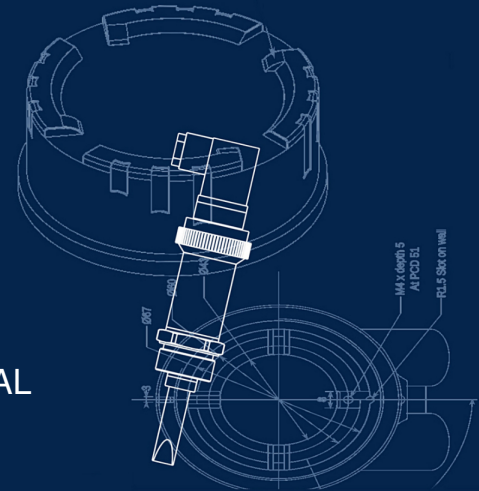

SAPCON INSTRUMENTS PVT. LTD.

30+ Years in Process Control Instrumentation

An ISO 22000 company

www.sapconinstruments.com

Contents

Revision History	7
1 Introduction	8
2 Operating Principle	8
3 Features	8
4 Applications	8
5 Electrical Specifications	9
6 Mechanical Specifications	9
7 Application Specifications	10
8 Installation Guidelines	10
9 Electrical Connections	10
10 Calibration	11
10.1 For Single Point Switching	11
10.1.1 Calibration for Non-conductive Material	11
10.1.2 Calibration for Conductive Material	11
10.2 For Two Point / Pump Control Logic	12
11 Cover Delay	12
11.1 For Single Point Switching	12
11.2 For Two Point / Pump Control Logic	13
12 Uncover Delay	13
12.1 For Single Point Switching	13
12.2 Two Point / Pump Control Logic	14
13 Sensitivity	14
14 Failsafe	15
15 Display Indications	15
15.1 STATUS LED	16
15.2 LED Bar Display	16
16 Factory Reset	16
17 Selection of Output Options	16
17.1 For Single Point / Two Point Switching	16
17.2 For Pump Control Logic	16
18 Indication of Output Options	17
19 Error Indication	17
20 For Namur Module	18
20.1 Electrical Specifications	18
20.2 Mechanical Specifications	18
21 Namur Isolation Barrier Specs	18
22 Installation Guidelines	19
22.1 Electrical Connections	19

22.2 Calibration	19
22.3 Normal Calibration	20
22.3.1 Calibration for Non-conductive Material	20
22.3.2 Calibration for Conductive Material	20
22.4 Remote Calibration	21
22.4.1 Calibration for Non-conductive Material	21
22.4.2 Calibration for Conductive Material	21
23 Output Current Configuration	22
23.1 Low Current Configuration	22
23.2 High Current Configuration	22
24 Sensitivity	23
25 Failsafe	24
26 Factory Reset	24
27 Certification	24
28 Maintenance	24
29 Customer Support	25
30 Namur Selection Order Code	26
31 Product Selection Order Code	28

List of Figures

1	Casper Product Image	8
2	Description of Parts	8
3	Proper Mounting Arrangement	10
4	Casper with Baffle	10
5	Cable Gland Arrangement	10
6	Electrical Connections (DPDT)	10
7	Calibration for Non-conductive Material	11
8	DIP Switch	11
9	Calibration Switch Position	11
10	Setting Calibration	11
11	Saving Calibration	11
12	Calibration with Material	11
13	HIGH Calibration Switch Position	12
14	Setting HIGH Calibration	12
15	Saving HIGH Calibration	12
16	Low Calibration	12
17	High Calibration	12
18	DIP Switch	12
19	Cover Delay Switch Position	13
20	Setting Cover Delay	13
21	Saving Cover Delay	13
22	Cover Delay Switch Position for Relay 2	13
23	Setting Cover Delay for Relay 2	13
24	Saving Cover Delay for Relay 2	13
25	Uncover Delay Switch Position	14
26	Setting Uncover Delay	14
27	Saving Uncover Delay	14
28	Uncover Delay Switch Position for Relay 2	14
29	Setting Uncover Delay for Relay 2	14
30	Saving Uncover Delay for Relay 2	14
31	Sensitivity Bar Display	14
32	Setting Sensitivity	15
33	Setting Sensitivity	15
34	Failsafe High	15
35	Failsafe Low	15
36	LED Indication on Top Cover	15
37	Demonstration of LED Bar Display	16
38	Switch Position	16

39	Setting Default Value	16
40	Saving Default Value	16
41	Single Point Switching without Material	17
42	Single Point Switching with Material	17
43	Two Point Switching	17
44	Pump Control Logic	17
45	Grounding Length in an Application Tank	19
46	Calibration at safe zone	19
47	Casper with Baffle	19
48	Cable Gland Arrangement	19
49	Electrical Connection during installation	19
50	Metallic Test Tank	20
51	Calibration without Material	20
52	DIP Switch	20
53	Calibration Switch Position	20
54	Setting Calibration	20
55	Saving Calibration	20
56	Calibration for Conductive Material	21
57	High Calibration Switch Position	21
58	Setting Calibration	21
59	Saving Calibration	21
60	Air Calibration Setup	21
61	Power ON Condition	21
62	Remote High Calibration Setup	22
63	High Calibration Power ON Condition	22
64	Switch Position Low Current Configuration	22
65	Setting of Low Current Configuration	22
66	Saving of Low Current Configuration	23
67	Sensitivity Setting	23
68	Sensitivity Switch Position	23
69	Setting Sensitivity Position	23
70	Saving Sensitivity	23
71	Failsafe High	24
72	Failsafe Low	24
73	Switch Position	24
74	Setting Default Value	24
75	Saving Default Value	24

List of Tables

1	Electrical Specifications	9
2	Mechanical Specifications	9
3	Application Specifications	10
4	Sensitivity	15
5	Error Indication	17
6	Electrical Specifications	18
7	Mechanical Specifications	18
8	Namur Isolation Barrier Specifications	18
9	Operating Conditions of Output Current	22
10	Switching Sensitivity	23
11	Certifications	24

Revision History

Revision	Date	Author(s)	Description
1.0	25 Aug 2019	RND	First Version Editing
1.1	4 May 2021	RND	Image Updation
1.2	3 Jun 2022	RND	Namur Section Added

1

1

- **Copyright:** All content on this document, such as text, graphics, logos and images is the property of Sapcon Instruments Pvt. Ltd. The selection, arrangement and presentation of all materials on this document and the overall design of this document is the exclusive property of Sapcon Instruments Pvt. Ltd.
- The images shown in this manual may differ from the actual instrument / housing in terms of dimensions, color and design. Please refer to GA drawings for dimensional details.
- Values (of performance) described in this manual were obtained under ideal testing conditions. Hence, they may differ under industrial environment and settings.

General Instructions

- Instrument shouldn't block the material filling inlet.
- Secure the cover of housing tightly. Tighten the cable glands. For side mounting, the cable glands should point downwards.
- For side mounting, provide a baffle to prevent the material from falling on the probe.
- When handling forks, do not lift them using their tines. While using them with solids, ensure that material size is less than 10mm.
- Deforming the shape of the tines may interfere with the fork's operating frequency.
- Make all electrical connections as instructed in the manual. Don't power on the device before verifying the connections.

1 Introduction

Casper is a microcontroller-based capacitance level limit switch. It is suitable for fine, coarse, bulky solids, non-sticky slurries, and liquids. The measuring system consists of an electronic insert and a probe. It works by utilizing the dielectric property of the application material.



Figure 1: Casper Product Image

2 Operating Principle

Casper works on the principle of capacitance. The probe comprises a sense electrode, electrically isolated from the metallic tank using a suitable insulator. The sense and the vessel wall serve as the two electrodes of a capacitor with the service material acting as the dielectric. A change in the level of material causes a change in the dielectric, which in turn causes the value of this tank capacitor to change.

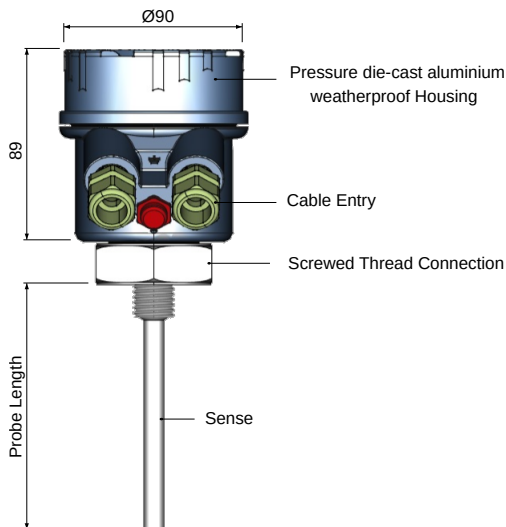

Figure 2: Description of Parts

3 Features

- Universal power supply of 18 - 55 V DC and 90 - 265 V AC on the same terminal.
- Customizable probe size.

- Output options: Relay, PNP and Analog.
- High temperature probe suitable for applications up to 250°C.
- Self-diagnosis for probe and electronics.
- Popular with a wide range of materials: low-to-high dielectric conductive materials / non-conductive material.

4 Applications

- Brewery
- Chemicals
- Dairy
- Food and Beverages
- Grain Handling

5 Electrical Specifications

Please refer to Table 6 for Electrical Specifications.

PARAMETER	VALUE
Input Power Supply	18 - 55V DC and 90 - 265V AC at 50Hz on same terminal
Available Output Options	<ul style="list-style-type: none"> • Relay SPDT , PNP • Relay DPDT
Power Consumption	<ul style="list-style-type: none"> • 1.5W (SPDT, PNP) at 24 V • 2.2W (DPDT) at 24 V
Switching	Single-point level switching / Two-point level switching
Switching Indication	For Relay 1 and Relay 2 Red - Alarm Green - Normal
Fail-safe	Two Field Selectable FS 1 & FS 2 <ul style="list-style-type: none"> • Open - Fail-safe High (For High Level) • Close - Fail-safe Low (For Low Level)
Time Delay Setting	1 - 25 seconds (For both, Covered and Uncovered Delays)
Relay Rating	6 Amps at 230V AC

Table 1: Electrical Specifications

6 Mechanical Specifications

Please refer to Table 7 for Mechanical Specifications.

PARAMETER	VALUE
Housing	<ul style="list-style-type: none"> • SCUTE: Pressure die-cast aluminium weatherproof (Rating IP-68) • FP2C: Cast aluminium, weatherproof & flameproof, powder coated, suitable for Gas Groups IIA, IIB & IIC as per IS-2148
Electrical Connector	2 x 1/2" BSP/NPT , PG 13.5
Operating Temperature	0°C to 60°C (Electronics)
Process Temperature	Up to 250°C
Operating Pressure	Up to 10 bar
Mounting	<ul style="list-style-type: none"> • Screwed: 1/2", 1", 1 1/2", 3/4" BSP / NPT • Flanged: As per user specification
Probe Length	100 mm to 3000 mm
Insulation	Full PTFE

Table 2: Mechanical Specifications

7 Application Specifications

Please refer to Table 3 for Application Specifications.

PARAMETER	VALUE
Response Time	1 second
Sensitivity	1 - 5

Table 3: Application Specifications

8 Installation Guidelines

While installing the instrument, please take care of the following points:

- In **Single Point Switching**, the instrument should be installed horizontally or vertically whereas in **Two Point Switching/Pump Control Logic** it should be vertically installed.

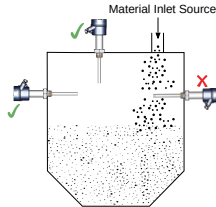

Figure 3: Proper Mounting Arrangement

- Observe that when installed directly under the material inlet source, a canopy called baffle of appropriate strength and size should be welded right above the instrument as shown.

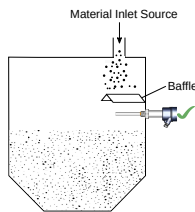

Figure 4: Casper with Baffle

- To prevent the ingress of moisture and water seepage in side mounting position, the cable entries should always point downwards.

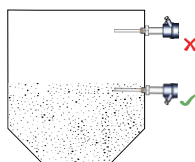

Figure 5: Cable Gland Arrangement

- Secure the cover of housing tightly. Tighten the cable glands.
- Make all electrical connections as instructed in the manual. Don't power on the device before verifying the connections.
- Weatherproofness of enclosure is guaranteed only if the cover is in place glands adequately tightened. Damage due to accidental entry of water can be avoided if the instrument is installed in a rain shade.
- If the ambient temperature is high, the instrument should not be installed to receive direct sunlight. In case such a position of shade is not available, a heat shield should be fitted above the instrument especially if the operating temperature lies between 60°C and 80°C.

9 Electrical Connections

Electrical connections for the instrument will change with the models. Please refer to figure 6 and the precautions mentioned below before connecting the device.

Precautions for connecting casper:

- Power Supply Rating**

Make sure the power supplied to the instrument is within the specified range mentioned in Table 6.

- Connect Earth**

When supplying AC power, please make sure that the grounding screw on the housing and the earth terminal are all connected to the plant's earth.

- Power Supply Fluctuations & Noise**

External noise or fluctuating power supplies could affect performance and shorten the life of the instrument. Use external line suppressors and fuse wires to contain the risk of damage to the circuit.

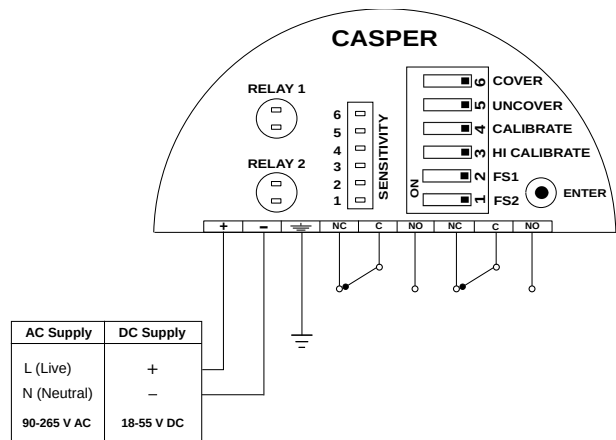

Figure 6: Electrical Connections (DPDT)

10 Calibration

The DIP switches for calibration and settings can be accessed by opening the top aluminium cover. Calibrating process depends on the conductivity of application material.

10.1 For Single Point Switching

10.1.1 Calibration for Non-conductive Material

Note: Calibration in air is specific to the tank, if the tank changes, the instrument needs to be calibrated again.

This calibration is also known as **Air Calibration** and **Calibration without material**. It should be done without the application material (i.e only air, no material). Once calibrated in the empty tank, the device can be used with a wide range of materials. Calibrating the instrument outside the tank can cause malfunctions.

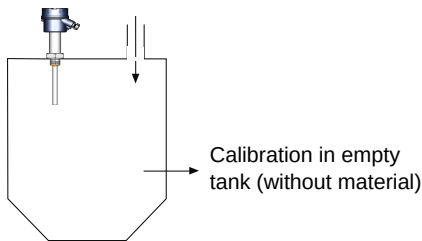

Figure 7: Calibration for Non-conductive Material

Follow the given procedure to calibrate the sensor:

- Install Casper in an empty tank.
- Unscrew the cover and ensure that all DIP switches are in the OPEN position as shown in Figure 52. Make sure that the STATUS LED is not blinking for error.

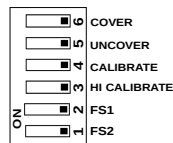

Figure 8: DIP Switch

- To start the calibration process, set the CALIBRATE switch to CLOSE (Opposite of OPEN for DIP switch) position as shown in Figure 53.

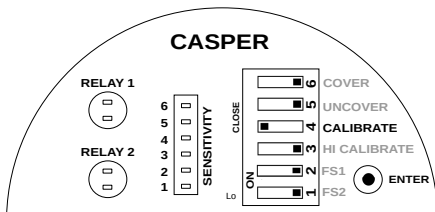

Figure 9: Calibration Switch Position

- Press and hold ENTER key. The STATUS LED for RELAY 1 will glow in RED color.

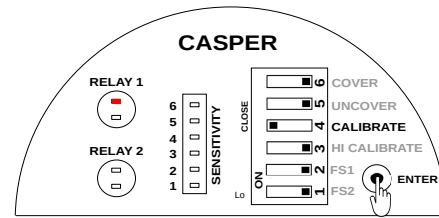

Figure 10: Setting Calibration

- Release the ENTER key and set the CALIBRATE switch back to OPEN position.

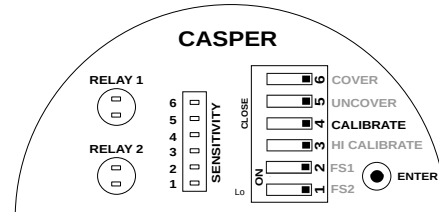

Figure 11: Saving Calibration

- Calibration is done.

10.1.2 Calibration for Conductive Material

This calibration is also known as **Calibration with material**. For applications using conductive materials (water, acid based pastes etc.), Casper needs to be calibrated with the application material. This will make the instrument specific to the application material i.e. if the application material is changed; calibration should be repeated.

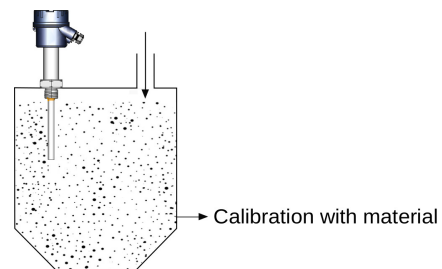

Figure 12: Calibration with Material

Follow the given procedure to calibrate the sensor:

- Fill the tank with the application material such that the Casper's probe is completely covered with the material.
- Unscrew the cover and make sure that all DIP switches are in the OPEN position as shown in Figure 52. Ensure that the STATUS LED is not blinking for error.
- To start with the calibration, set the HI CALIBRATE switch to CLOSE (Opposite of OPEN for DIP switch)

position as shown in Figure 57 and wait until Green LED becomes stable.

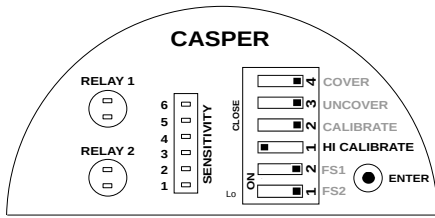

Figure 13: HIGH Calibration Switch Position

- Press and hold ENTER key, the STATUS LED for RELAY 1 will glow in RED color as shown in Figure 58.

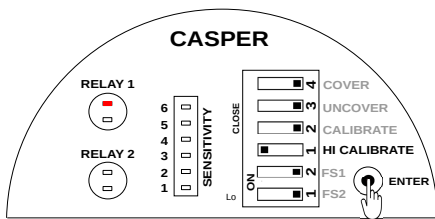

Figure 14: Setting HIGH Calibration

- Release the ENTER key and set the HI CALIBRATE switch back to OPEN position as shown in Figure 59.

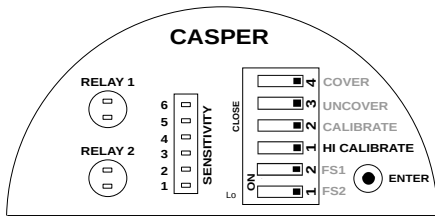

Figure 15: Saving HIGH Calibration

- Calibration is complete.

10.2 For Two Point / Pump Control Logic

1. **Low Calibration** For Low Calibration, fill the tank with the application material such that it touches the tip of Casper's probe as shown in Figure 16 and follow the instructions given in the section Calibration for Non-conductive Material.
2. **High Calibration** For High Calibration, fill the tank with the application material such that the Casper's probe is completely covered with the material as shown in Figure 17 and follow the instructions given in the section Calibration for Conductive Material.

11 Cover Delay

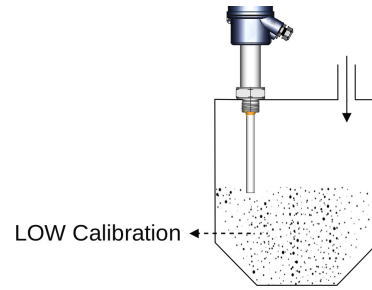

Figure 16: Low Calibration

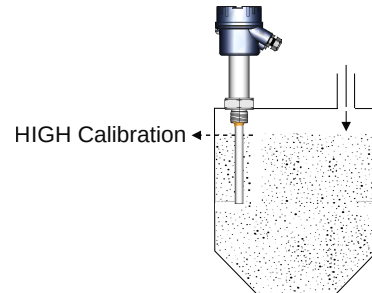

Figure 17: High Calibration

When the application material covers the probe, the changeover of the output can be delayed by a pre-determined time. This time is called Cover Delay. For a different value of cover delay, the number of blinks can be adjusted as per requirement.

The STATUS LED will start blinking RED if the switch point is reached. It will blink for the number of seconds for which the cover delay is set. 1 blink is equal to 1 second during switching.

Note: Set the value of COVER DELAY between 1-25 secs.

11.1 For Single Point Switching

- Unscrew the cover and ensure that all DIP switches are in OPEN position as shown in Figure 18. Make sure that STATUS LED is not blinking for error.

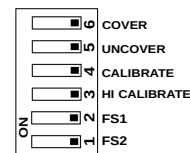

Figure 18: DIP Switch

- Set the COVER switch to CLOSE (Opposite of OPEN for DIP switch) position as shown in Figure 19.
- Press and hold ENTER key as shown in Figure 20. The STATUS LED for RELAY 1 starts blinking. Blink the LED according to value of cover delay.

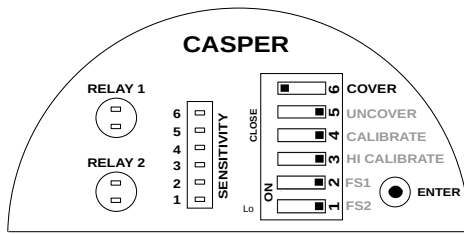

Figure 19: Cover Delay Switch Position

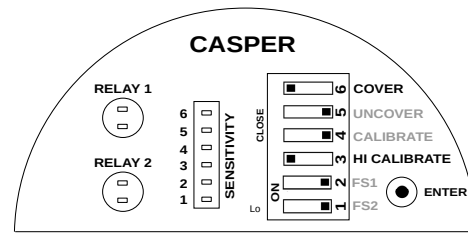

Figure 22: Cover Delay Switch Position for Relay 2

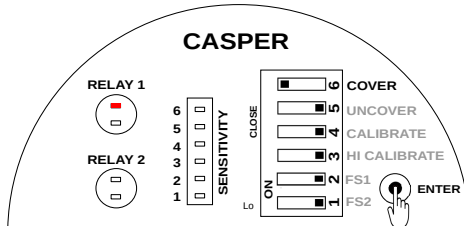

Figure 20: Setting Cover Delay

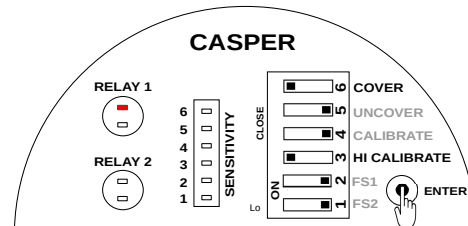

Figure 23: Setting Cover Delay for Relay 2

- Delay is entered, but not saved. To save and test the cover delay, set the COVER switch back to OPEN position as shown in Figure 21.

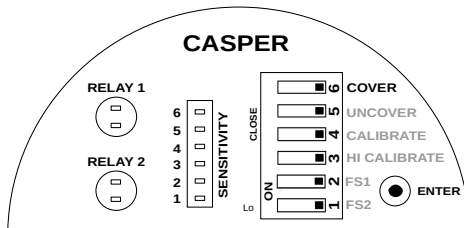

Figure 21: Saving Cover Delay

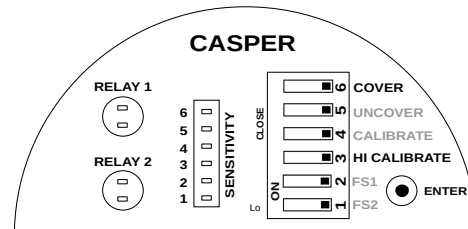

Figure 24: Saving Cover Delay for Relay 2

- To test, dip Casper into the application material until the switching point is reached.

11.2 For Two Point / Pump Control Logic

- Unscrew the cover and ensure that all DIP switches are in OPEN position as shown in Figure 18. Make sure that STATUS LED is not blinking for Error.
- For setting cover delay for RELAY 1, follow the instruction given in section Single Point Switching.
- For setting cover delay for RELAY 2, set the COVER and HI CALIBRATE switch to CLOSE (Opposite of OPEN for DIP switch) position as shown in Figure 22.
- Press and hold ENTER key as shown in Figure 23. The STATUS LED for RELAY 1 starts blinking. Blink the LED according to value of cover delay.
- Delay is entered, but not saved. To save and test the cover delay, set the COVER and HI CALIBRATE switch back to OPEN position as shown in Figure 24.
- To test, dip Casper into the application material until the switching point is reached.

12 Uncover Delay

When the application material uncovers Casper's probe, the changeover of the output can be delayed by a pre-determined time. This time is called UNCOVER Delay. For a different value of uncover delay, the number of blinks can be adjusted as per requirement.

The STATUS LED will start blinking RED if the switch point is achieved. It will blink for the number of seconds for which the uncover delay is set.

Note: Set the value of UNCOVER DELAY between 1-25 secs.

12.1 For Single Point Switching

- Unscrew the cover and ensure that all DIP switches are in OPEN position as shown in Figure 18. Make sure that STATUS LED is not blinking for error.
- Set the UNCOVER switch to CLOSE (Opposite of OPEN for DIP switch) position as shown in Figure 25.
- Press and hold ENTER key as shown in Figure 26. The STATUS LED for RELAY 1 starts blinking. Blink the LED according to value of uncover delay.

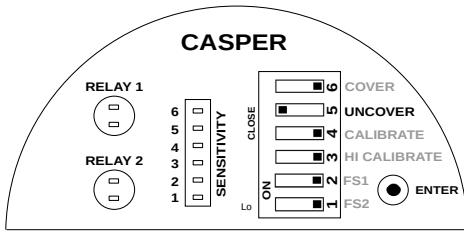

Figure 25: Uncover Delay Switch Position

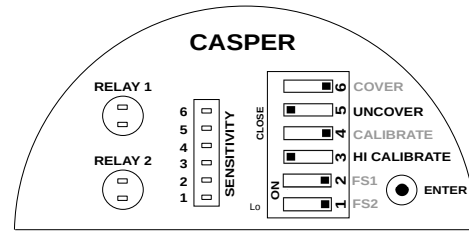

Figure 28: Uncover Delay Switch Position for Relay 2

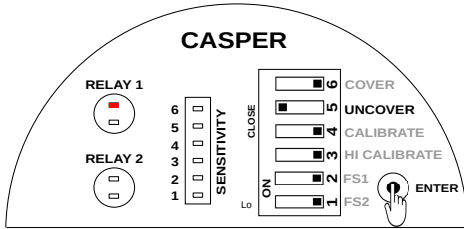

Figure 26: Setting Uncover Delay

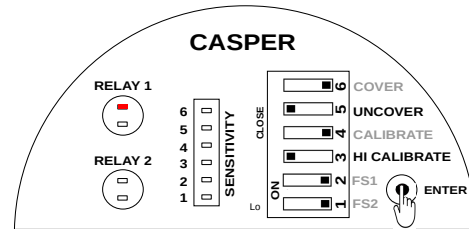

Figure 29: Setting Uncover Delay for Relay 2

- Uncover delay is entered, but not saved. To save and test the uncover delay, set the UNCOVER switch back to OPEN position as shown in figure 27.

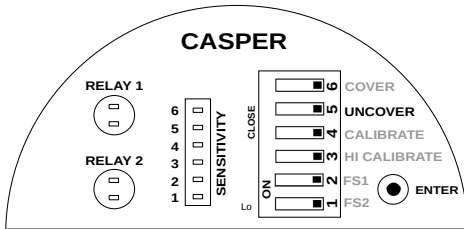

Figure 27: Saving Uncover Delay

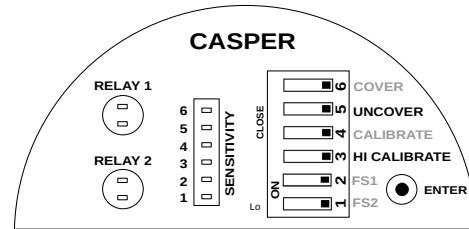

Figure 30: Saving Uncover Delay for Relay 2

- To test, dip Casper into the application material until the switching point is achieved.

- To test, dip Casper into the application material until the switching point is achieved.

12.2 Two Point / Pump Control Logic

- Unscrew the cover and ensure that all DIP switches are in OPEN position as shown in Figure 18. Make sure that STATUS LED is not blinking for error.
- For setting uncover delay for RELAY 1, follow the instruction given in section Single Point Switching.
- For setting uncover delay for RELAY 2, set the UNCOVER and HI CALIBRATE switch to CLOSE (Opposite of OPEN for DIP switch) position as shown in Figure 28.
- Press and hold ENTER key as shown in Figure 29. The STATUS LED for RELAY 1 starts blinking. Blink the LED according to value of uncover delay.
- Uncover Delay is entered, but not saved. To save and test the uncover delay, set the UNCOVER switch back to OPEN position as shown in figure 30.

13 Sensitivity

Sensitivity of the level sensor may have to be adjusted depending on the dielectric constant of the application media. Casper has a LED bar display which helps in visualizing the desired sensitivity level. The device ships with a default sensitivity level of 3.

Note: Set the sensitivity value between 1-5.

Traverse the following steps to set the sensitivity:

- Set the UNCOVER and CALIBRATE switch to CLOSE position.

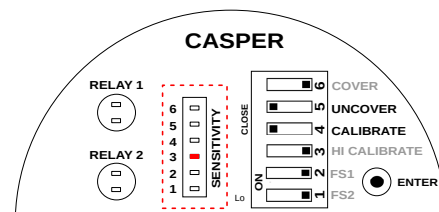

Figure 31: Sensitivity Bar Display

- The Sensitivity Bar Display will indicate the current sensitivity value. As can be seen in the Figure 31, the value been shown here is 3.
- To modify the set value, Press ENTER and HOLD the key, RED STATUS LED for RELAY 1 will start blinking. Count the number of times the LED blinks and release the ENTER key after the required value. e.g. For setting the sensitivity to 4, count up to four blinks and release the ENTER key.

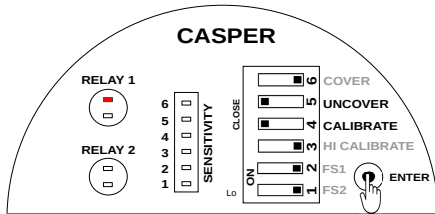

Figure 32: Setting Sensitivity

- To save the sensitivity value, set the UNCOVER and CALIBRATE switches back to OPEN position.

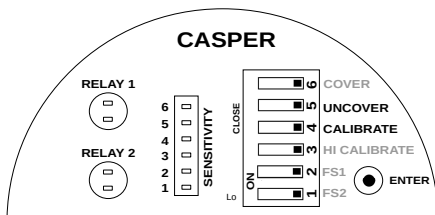

Figure 33: Setting Sensitivity

- Check operation of Casper by filling in and draining out the material.
- If the instrument does not switch when covered with the material, try again with a higher value of sensitivity.
- If the instrument does not switch back to the uncovered state, try with a lower sensitivity value.

Please refer to Table 10 before selecting sensitivity value.

SENSITIVITY	DIELECTRIC CONSTANT
1	> 30
2	20-30
3	5-20
4	2-5
5	> 1.5 & < 2

Table 4: Sensitivity

14 Failsafe

In a condition of device failure, known errors and input power failure the outputs of the device resemble the ALARM condition. This is meant to prevent overflow or dry run conditions in case of failures.

Prevent Overflow - High Level Switch Failsafe High (default) is set by moving the FS 1 and FS 2 switch for relay 1 and 2 to OPEN position.

1. When not in contact with the material, LED turns GREEN.
2. When in contact with the material, LED turns RED.

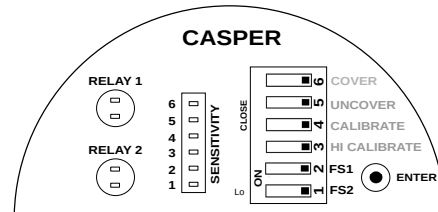

Figure 34: Failsafe High

Prevent Dry run - Low Level Switch Failsafe Low is set by moving the FS 1 and FS 2 switch for relay 1 and 2 switch to CLOSE position.

Note: LO in top cover indicates failsafe low.

1. When in contact with the material, LED turns GREEN.
2. When not in contact with the material, LED turns RED.

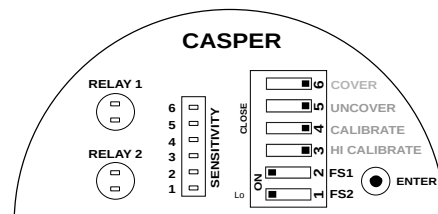

Figure 35: Failsafe Low

15 Display Indications

As seen in Fig.36, Casper has STATUS LEDs and a 6-point LED bar display.

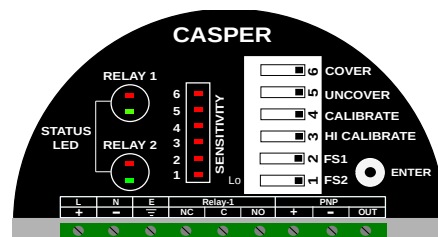

Figure 36: LED Indication on Top Cover

15.1 STATUS LED

Two separate STATUS LED sections indicate switching status for RELAY 1 and RELAY 2.

- **RED** LED: Alarm Condition
- **GREEN** LED: Normal Condition

Continuous blinking of Red or Green LED could indicate an error, refer to Error Indication

15.2 LED Bar Display

A numeric LED Bar displays helps to visualize switching point and sensitivity values.

Use of LED Bar Display: The bar display can be used for two purpose:

- Sensitivity: Refer to section Sensitivity for more details.
- Display Mode: The display mode shows the material distance from the instrument's probe. The movement of LEDs in upward direction depicts the movement of application media towards Casper's probe and vice-versa, as shown in Figure 37.

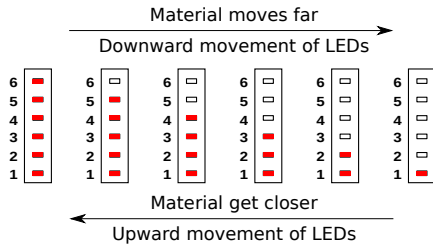

Figure 37: Demonstration of LED Bar Display

16 Factory Reset

Follow the steps given below to reset the time delays and sensitivity value to default values. Factory Reset does not reset any calibration values:

- Set the CALIBRATE, COVER and UNCOVER switches to CLOSE position.

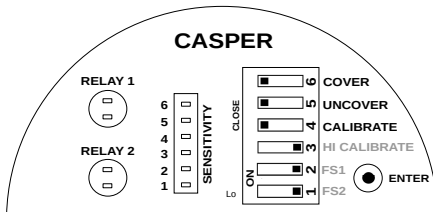

Figure 38: Switch Position

- Press and hold the ENTER key until the STATUS LED blinks.
- Set the CALIBRATE, COVER and UNCOVER switches back to OPEN position.

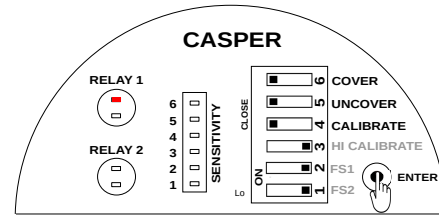

Figure 39: Setting Default Value

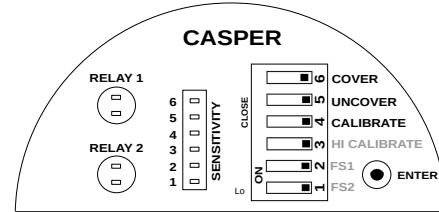

Figure 40: Saving Default Value

- This will set the time delay to 0 and the sensitivity level to 3.

17 Selection of Output Options

Casper can be used with 3 output options as per requirement which are as follows:

1. Single Point Switching
2. Two Point Switching
3. Pump Control Logic

Note: While changing the configuration mode the value of Time Delays and Sensitivity will changed to default value.

17.1 For Single Point / Two Point Switching

- Set the COVER and UNCOVER switches to CLOSE position.
- Press and hold ENTER Key. The STATUS LED of RELAY 1 starts blinking.
- Release the ENTER key after 1 blink to set **Single Point Switching**.
- Release the ENTER key after 2 blink to set **Two Point Switching**.

17.2 For Pump Control Logic

- Set the COVER and CALIBRATE switches to CLOSE position.
- Press and hold ENTER Key. The STATUS LED of RELAY 1 starts blinking.
- Release the Enter key after 1 blink to ON the **Pump Control Logic**.

- Release the Enter Key after 2 blink to OFF the **Pump Control Logic**.

18 Indication of Output Options

Depending on the selection mode for output, the two relay outputs can also operate independently for two different switch points. Refer to Order Code

- All keys should be in the OPEN position.
- To see the output mode, press and hold ENTER key.
- If the only the first LED lights up, Casper is operating in the single point switching mode without material.

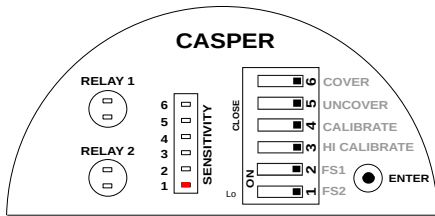

Figure 41: Single Point Switching without Material

- If only the 2nd LED light up, then the instrument is operating in the single point switching mode with material.

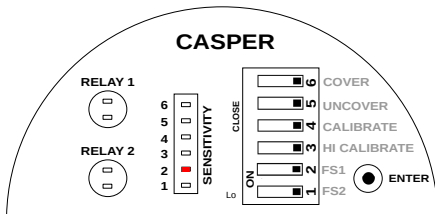

Figure 42: Single Point Switching with Material

- If only the 3rd LED light up, then the instrument is operating in the two point switching mode.

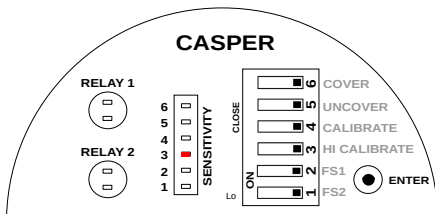

Figure 43: Two Point Switching

- If 3rd & 4th LED light up, then the instrument is operating in the pump control logic.

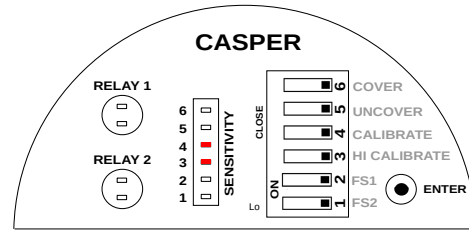

Figure 44: Pump Control Logic

19 Error Indication

On error, the status LED starts blinking RED and GREEN alternately at a faster rate. Normal LED blinks are always at the rate of 1 blink per second, in either RED or GREEN color. In some cases, a GREEN or a RED blinking could indicate an error. Refer to Table 5 for a list of errors and their indication.

INDICATION	DESCRIPTION	TROUBLESHOOTING
RED-GREEN Blinking	Calibration Error	Recalibrate the instrument, make sure that the probe is calibrated in an empty metal-body tank.
RED Blinking	Probe Short-Circuit	Moisture deposition in the probe connector. Clean the connector and use the instrument.
GREEN Blinking	Probe Open	Remove the electronic insert from the housing and check the cable connections of the probe.
3 Times GREEN Blinking and 1 Red Blink	Illegal Key Combination	Switch all DIP switches to open position. Use only legal combination of keys.
3 Times RED Blinking and 1 GREEN Blink	Circuit Error	Contact the Customer Support department at Sapcon.

Table 5: Error Indication

20 For Namur Module

20.1 Electrical Specifications

Please refer to Table 6 for Electrical Specifications.

PARAMETER	VALUE
Input Power Supply	NMR: 8.5 ± 0.2 V DC. Namur type current output (I ON \geq 2.1 mA, I OFF \leq 1.2 mA) Namur compliance can be attained with a Namur certified isolator.
Switching	Single-point level switching / Pump Control Logic
Switching Indication	Red - Alarm & Green - Normal
Fail-safe	Field Selectable: Open - Fail-safe High (For High Level) Close - Fail-safe Low (For Low Level)

Table 6: Electrical Specifications

20.2 Mechanical Specifications

Please refer to Table 7 for Mechanical Specifications.

PARAMETER	VALUE
Housing	<ul style="list-style-type: none"> • SCUTE: Pressure die-cast aluminium weatherproof (Rating IP-68) • FP2C: Cast aluminium, weatherproof & flameproof, powder coated, suitable for Gas Groups IIA, IIB & IIC as per IS-2148 (Rating IP-66)
Cable Gland	2 x 1/2" BSP/NPT , PG 13.5
Operating Temperature	-20°C to 60°C (Electronics)
Mounting	<ul style="list-style-type: none"> • Screwed: 1/2", 1", 1 1/2", 3/4" BSP / NPT • Flanged: As per user specification
Probe Length	100 mm to 3000 mm
Insulation	Full PTFE

Table 7: Mechanical Specifications

21 Namur Isolation Barrier Specs

The 'NMR' electronics of the Coat-Endure requires the following specifications to be functional:

Parameter	Value
Functional Operating Voltage	8.5 ± 0.2 V DC
Internal Source Resistance	1K Ω
Absolute Maximum Voltage	UI & UO = 13 V
Current Consumption	II & IO = 16 mA
Power Consumption	PI & PO = 65 mW
Input Capacitance	0 uF
Input Inductance	LI = 22 uH
Certification	Ex ia IIC T6 Ga (-20°C \leq Tamb \leq 60°C)

Table 8: Namur Isolation Barrier Specifications

22 Installation Guidelines

The Casper can be installed in the vessel in almost any position. While installing, please take care of the following points:

- Ensure that atleast 10 mm for the "Grounding" electrode on the Casper probe should be completely inside the application tank. i.e. No part of sense electrode should be inside the nozzle.

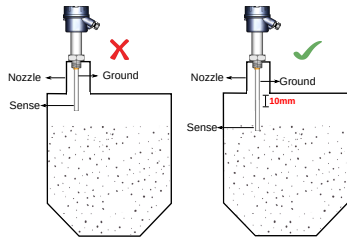

Figure 45: Grounding Length in an Application Tank

- Before Installing the device, ensure that the calibration process has been already carried out in safe area (Zone 2) then install the instrument in hazardous area as shown in Figure 51

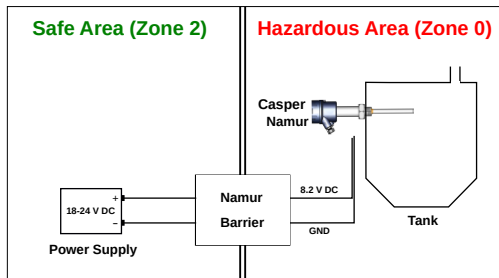

Figure 46: Calibration at safe zone

- For remote calibration, install the instrument in an application tank and then perform the calibration process in hazardous area (Zone 0).
- The instrument shouldn't block the material filling inlet.
- Secure the cover of housing tightly. Tighten the cable glands.
- For side-mounting, provide a baffle to prevent the material from falling on the probe. Please refer to Figure 47.
- To prevent the ingress of moisture and water seepage in side mounting position, the cable entries should always point downwards as shown in Figure 48.
- Make all electrical connections as instructed in the manual. Don't power on the device before verifying connections.

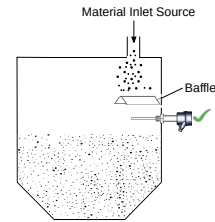

Figure 47: Casper with Baffle

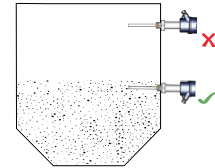

Figure 48: Cable Gland Arrangement

- Weatherproofness of enclosure is guaranteed only if the cover is in place glands adequately tightened. Damage due to accidental entry of water can be avoided if the instrument is installed in a rain shade.
- If the ambient temperature is high, the instrument should not be installed to receive direct sunlight. In case such a position of shade is not available, a heat shield should be fitted above the instrument especially if the operating temperature is 60 °C.
- While screwing the Casper, the hexagonal mounting bush should be turned and not the housing.

22.1 Electrical Connections

Please refer to the Figure 49 for electrical connections while connecting the instrument in an application tank.

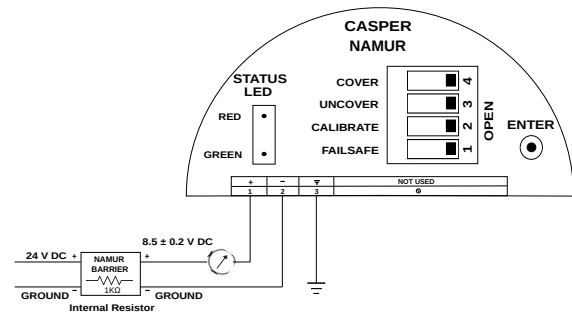

Figure 49: Electrical Connection during installation

22.2 Calibration

Calibration for the level sensor has to be carried out at the installation site. Calibration cannot be skipped and is essential for level sensor's operation. Calibration of Casper can be performed with the help of two different methods which are as follows:

- Normal Calibration
- Remote Calibration

22.3 Normal Calibration

Note: Perform the Normal Calibration of the level instrument only in a Safe Zone (Zone 2).

22.3.1 Calibration for Non-conductive Material

This calibration is also known as **Air Calibration** and **Calibration without material**. It should be done without the application material (i.e only air, no material).

It is recommended to first calibrate the Casper in a more convenient setup in Safe Zone(Zone 2) before installing it in an application tank.

To carry out calibration process, please follow the steps mentioned below:

- Prepare a transparent Metallic Test Tank as shown in the following Figure 50.

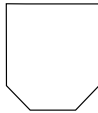

Figure 50: Metallic Test Tank

- Refer to given Figure 49 for Electrical Connections to power up and connect the device.
- Dip the Casper into test tank as shown in Figure 51.

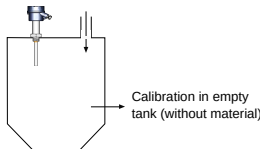

Figure 51: Calibration without Material

- Unscrew the cover and ensure that all DIP switches are in the OPEN position as shown in Figure 52. Make sure that the status LED is not blinking for error.



Figure 52: DIP Switch

- To start the calibration process, set the CALIBRATE switch to CLOSE (Opposite of OPEN in a DIP switch) position as shown in Figure 53.
- Press and hold ENTER key. The STATUS LED will glow in RED color.
- Release the ENTER key and set the CALIBRATE switch back to OPEN position.

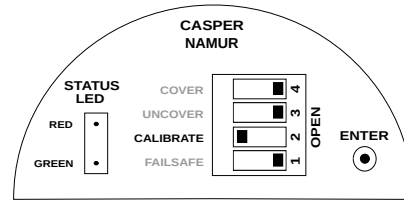

Figure 53: Calibration Switch Position

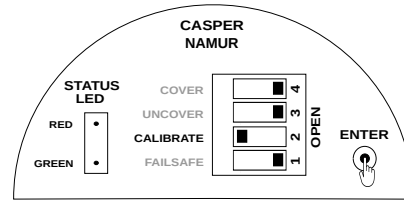

Figure 54: Setting Calibration

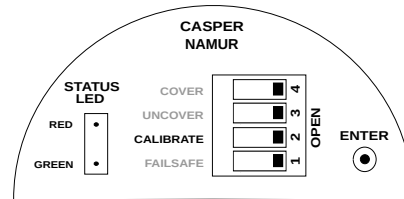

Figure 55: Saving Calibration

- Air calibration is done.
- Proceed to Section [Installation Guidelines](#) for installing the product in an application tank.

22.3.2 Calibration for Conductive Material

This calibration is also known as **Calibration with material**. For applications using conductive materials (water, acid based pastes etc.), Casper needs to be calibrated with an application material. This will make the instrument specific to the application material i.e. if the application material is changed; calibration should be repeated.

It is recommended to first calibrate the Casper in a more convenient setup in Safe Zone(Zone 2) before installing it in the application tank.

To carry out calibration process, please follow the steps mentioned below:

- Prepare a transparent Metallic Test Tank as shown in the following Figure 50.
- Refer to given Figure 49 for Electrical Connections to power up and connect the device.
- Dip the Casper in test tank & fill the tank with the application material such that the Casper's probe is completely covered with the material.
- Unscrew the cover and make sure that all DIP switches are in the OPEN position as shown in Figure 52. Ensure that the STATUS LED is not blinking for error.

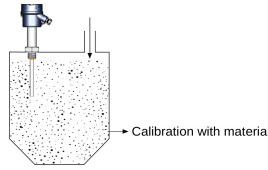

Figure 56: Calibration for Conductive Material

- To start with the calibration, set the CALIBRATE & COVER switch to CLOSE (Opposite of OPEN for DIP switch) position as shown in Figure57.

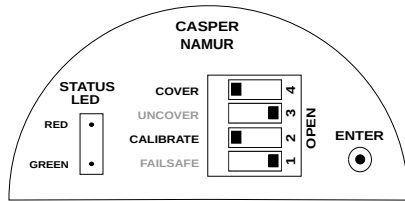

Figure 57: High Calibration Switch Position

- Press and hold ENTER key, the STATUS LED will glow in RED color as shown in Figure 58.

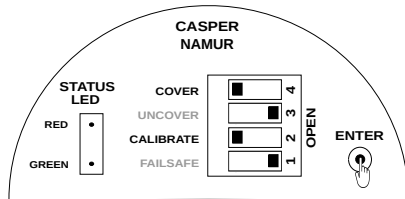

Figure 58: Setting Calibration

- Release the ENTER key and wait for 25 - 30 seconds.
- Set the CALIBRATE and COVER switch back to OPEN position as shown in Figure 59.

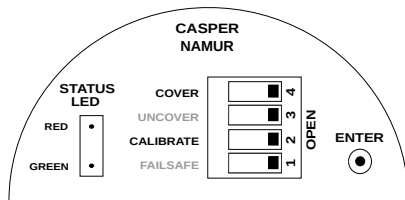

Figure 59: Saving Calibration

- High Calibration is complete.
- Proceed to Section [Installation Guidelines](#) for installing the product in an application tank.

22.4 Remote Calibration

Note: Remote calibration is performed when test tank is not available in Safe Zone (Zone 2) and calibration needs to be performed in Hazardous Zone (Zone 0).

22.4.1 Calibration for Non-conductive Material

This calibration is also known as **Air Calibration** and **Calibration without material**. It should be done without the application material (i.e only air, no material).

Note: Power OFF the level instrument before starting the calibration process.

To carry out calibration process, please follow the steps mentioned below:

- Ensure that all DIP switches are in the OPEN position.

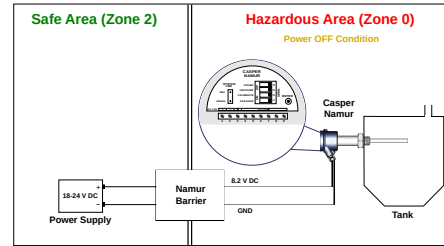

Figure 60: Air Calibration Setup

- Set the CALIBRATE switch to CLOSE (Opposite of OPEN in a DIP switch) position as shown in Figure 53.
- Close the cover of housing properly before powering on the instrument.
- Power ON the instrument and wait for a minimum of 60 seconds.

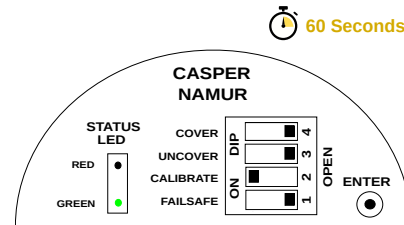

Figure 61: Power ON Condition

- Power OFF the instrument.
- Open the housing cover and set the CALIBRATE switch back to OPEN position as shown in Figure 55.
- Close the cover of housing properly.
- Power ON the instrument.
- Low calibration is completed.

22.4.2 Calibration for Conductive Material

For applications using conductive materials (water, acid based pastes etc.), Casper needs to be calibrated with the application material. This will make the instrument specific to the application material i.e. if the application material is changed; calibration should be repeated.

Note: Power OFF the level instrument before starting the calibration process.

To carry out calibration process, please follow the steps mentioned below:

- Ensure that all DIP switches are in the OPEN position.

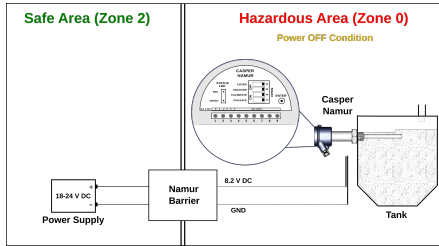

Figure 62: Remote High Calibration Setup

- Set the CALIBRATE and COVER switch to CLOSE (Opposite of OPEN in a DIP switch) position as shown in Figure 57.
- Close the cover of housing properly before powering on the instrument.
- Power ON the instrument and wait for a minimum of 60 seconds.

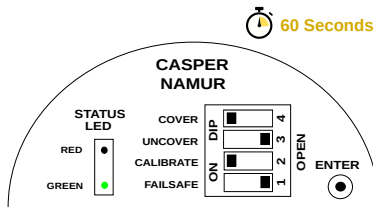

Figure 63: High Calibration Power ON Condition

- Power OFF the instrument.
- Open the housing cover and set the CALIBRATE and COVER switch back to OPEN position as shown in Figure 59.
- Close the cover of housing properly.
- Power ON the instrument.
- High calibration is completed.

23 Output Current Configuration

Note: Perform the operation of Output Current Configuration of the level instrument only in a Safe Zone (Zone 2).

Namur isolation barriers as specified in the Table 9 tend to have variation in their "Functional Operating Voltage". Change to the "Functional Operating Voltage" may cause a change in power consumption for Casper Namur level sensor. The output current can be configured as required as

per the procedure mentioned below:

If the output current of alarm condition exceeds or goes below the specified limit only then use Low Current Configuration or High Current Configuration as per the current value.

STATUS	OUTPUT CURRENT
Normal Condition	$\leq 1.2\text{mA}$
Alarm Condition	$\geq 2.1\text{mA}$ and $< 3\text{mA}$

Table 9: Operating Conditions of Output Current

23.1 Low Current Configuration

If the output current of alarm condition is exceeded over 3mA then the instrument does not operate properly which results instrument will not be able to switch. To resolve this condition, the value of output current should be adjusted by setting Low Current Configuration. To set this mode please follow the procedure given below:

- Set the COVER and UNCOVER switch to CLOSE position.

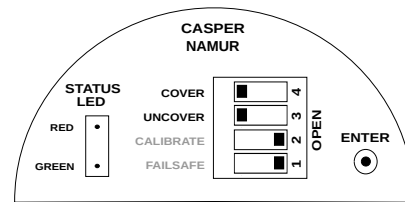

Figure 64: Switch Position Low Current Configuration

- Press and Hold the ENTER key, RED Status LED will start blinking.

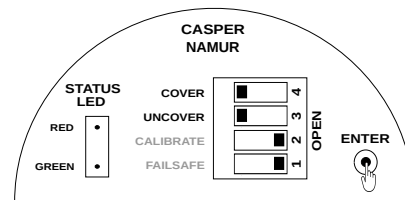

Figure 65: Setting of Low Current Configuration

- Blink the RED LED 2 times and release the ENTER key.
- Low Current Configuration mode is set.

23.2 High Current Configuration

If the output current of alarm condition goes below 2.1mA then the instrument does not operate properly which results instrument will not be able to switch. To resolve this condition, the value of output current should be adjusted by setting High Current Configuration. **Indication of this mode is**

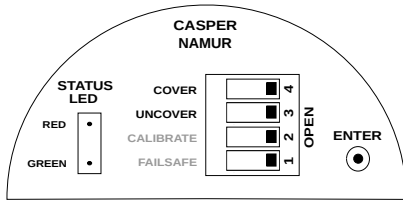

Figure 66: Saving of Low Current Configuration

shown by constantly glowing GREEN LED of STATUS LED. To set this mode please follow the procedure given below:

- Set the COVER and UNCOVER switch to CLOSE position as per Figure 64.
- Press and Hold the ENTER key, RED Status LED will start blinking as per Figure 65.
- Blink the RED LED only once and release the ENTER key as per Figure 66.
- High Current Configuration mode is set.

24 Sensitivity

Note: Set the sensitivity value between 1-5.

The instrument has 5-point sensitivity level to suit a wide range of application materials. Sensitivity value should be decided with respect to the dielectric constant of the application material. Refer to table 10 for selecting a suitable value. By default, the sensitivity is set to 3 to suit a wide range of materials. Traverse the following steps to set the sensitivity:

Note: Set the Sensitivity of the level instrument only in a Safe Zone (Zone 2).

1. Power OFF the instrument and unscrew the electronics insert from the enclosure using screw driver.

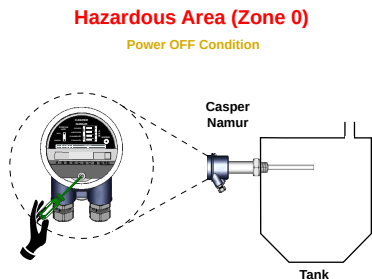

Figure 67: Sensitivity Setting

2. Kept the electronics in Safe Zone(Zone 2) and then set the Sensitivity.
3. Refer to given Figure 49 for Electrical Connections to power up and connect the device.
4. Select a sensitivity value for the product as per table 10.

DIELECTRIC CONSTANT	SENSITIVITY VALUE
High	1 – 2
Low	3 – 5 (default)

Table 10: Switching Sensitivity

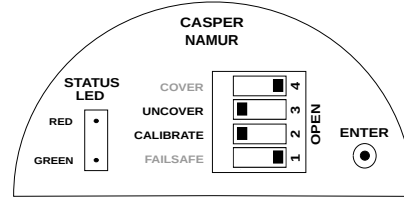

Figure 68: Sensitivity Switch Position

5. Set the CALIBRATE and UNCOVER switch to CLOSE position.
6. To modify the set value, Press ENTER and HOLD the key, RED Status LED will start blinking. Count the number of times the LED blinks and release the ENTER key after the required value. e.g. For setting the sensitivity to 4, count up to four blinks and release the ENTER key.

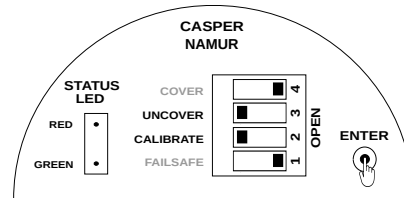

Figure 69: Setting Sensitivity Position

7. To save the sensitivity value, set the CALIBRATE and UNCOVER switches back to OPEN position.

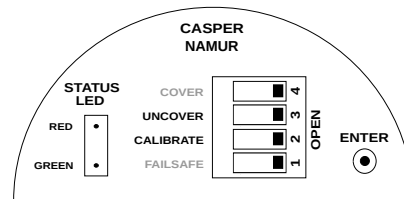

Figure 70: Saving Sensitivity

8. Check operation of Casper by filling in and draining out the material.
9. If the instrument does not switch when covered fully with the material, try again with a higher value of sensitivity.
10. If the instrument switches when covered fully with the material, but does not switch back to normal state

when uncovered, try again with a lower sensitivity value.

25 Failsafe

In a condition of device failure, known errors and input power failure the outputs of the device resemble the ALARM condition. This is meant to prevent overflow or dry run conditions in case of failures.

Prevent Overflow - High Level Switch Failsafe High (default) is set by moving the FAILSAFE switch to OPEN position.

1. When not in contact with the material, LED turns GREEN.
2. When in contact with the material, LED turns RED.

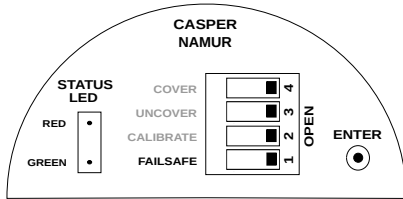

Figure 71: Failsafe High

Prevent Dry run - Low Level Switch Failsafe Low is set by moving the FAILSAFE switch to CLOSE position.

1. When in contact with the material, LED turns GREEN.
2. When not in contact with the material, LED turns RED.

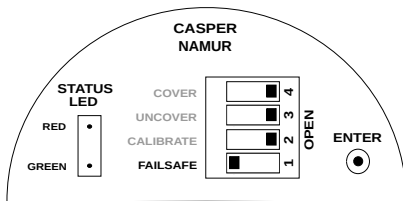

Figure 72: Failsafe Low

26 Factory Reset

Follow the steps given below to reset the time delays and sensitivity value to default values. Factory Rest does not reset any calibration values.

1. Set the CALIBRATE, COVER and UNCOVER switches to CLOSE position.
2. Press and hold the ENTER key until the STATUS LED blinks.
3. Set the CALIBRATE, COVER and UNCOVER switches back to OPEN position.
4. This will set the time delay to 0 and the sensitivity level to 3.

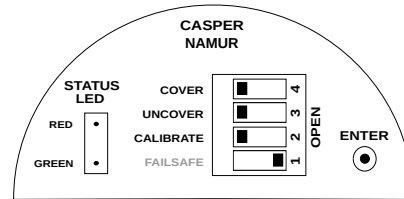

Figure 73: Switch Position

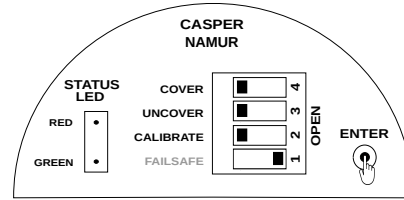

Figure 74: Setting Default Value

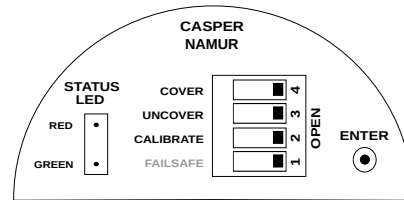

Figure 75: Saving Default Value

27 Certification

Please refer to Table 11 for Certifications.

CERTIFICATION	ITEM SELECTION
IS/IEC 60529: 2001 (IP68)	SCUTE
IS/IEC 60529: 2001 (IP66)	FP2C
IS/IEC 60079-1:2014 (Ex 'd')	FP2C
Ex ia IIC T3 Ga	NMR-DC6

Table 11: Certifications

28 Maintenance

The electronics of Casper needs no maintenance. When cleaning and checking the vessel, free the Casper from deposits. If the material has tendency to form a hard sticky deposit, the instrument must be checked more often. Make sure that the cable ducts and the lid are tightly sealed so that no moisture seeps into the instrument.

29 Customer Support

Thank you for going through the instructions given in this manual. To further ease the process of installation and use, we have developed special demo videos which are hosted on YouTube.

Sapcon's YouTube channel, SAPCON INSTRUMENTS, lists all these videos: <https://goo.gl/dnxfcz>

Should you require further information regarding installation, use or working of the instrument, please don't hesitate to contact us. Kindly provide the following information at the time of contacting:

- Instrument Model and Serial Number
- Purchase Order Number and Date of Purchase
- Description of the query
- Your contact details

In an attempt to serve you better, we are open seven days a week (9:30am to 7:30pm). We are available at:

- www.sapconinstruments.com
- sales@sapcon.in
- +91-731-4757575

30 Namur Selection Order Code

Product

CPR : Casper - Microcontroller based Capacitance type Level Limit Switch (Use in Fine Powder, Bulky Solids, Slurries, Liquids etc.)

Type

I : Integral (sensor in same unit)

Housing

SCUTE : Pressure die-cast aluminium weatherproof (Rating IP68)

FP2C : Cast aluminium weather & flameproof powder coated paint suitable for Gas Group IIC (Rating IP-66)

Probe Housing Cable Entry

PCPG13 : PG 13.5, Polyamide

PCB5D : 1/2" BSP, DC Gland, Brass

PCN5D : 1/2" NPT, DC Gland, Brass

Output

NMR : Namur type current output at 8.5 ± 0.2 V DC ($I_{ON} \geq 2.1$ mA and $I_{OFF} \leq 1.2$ mA)

Power Supply

DC6 : 8.5 ± 0.2 V DC supplied by NAMUR certified isolator should contain $1K\Omega$ Internal Resistor

Reference (Except 1/2", 3/4" Mounting)

REF : Yes (Incase of Non-Metallic Tanks)

STWGI : Still Well

STWS4 : Still Well

STWS6 : Still Well

Probe Type

RDP : Rod Probe

Mounting

MB5S6 : Screwed Thread, BSP 1/2", SS 316

MN5S6 : Screwed Thread, NPT 1/2", SS 316

MB7S6 : Screwed Thread, BSP 3/4", SS 316

MN7S6 : Screwed Thread, NPT 3/4", SS 316

MB10S6 : Screwed Thread, BSP 1", SS 316

MN10S6 : Screwed Thread, NPT 1", SS 316

MB15S4 : Screwed Thread, BSP 1-1/2", SS 304

MB15S6 : Screwed Thread, BSP 1-1/2", SS 316

MN15S4 : Screwed Thread, NPT 1-1/2", SS 304

MN15S6 : Screwed Thread, NPT 1-1/2", SS 316

FA10MS : 1" ANSI/ASME B16.5 Flange, MS Plated

FA10S6 : 1" ANSI/ASME B16.5 Flange, SS 316

FA15MS : 1-1/2" ANSI/ASME B16.5 Flange, MS Plated

FA15S4 : 1-1/2" ANSI/ASME B16.5 Flange, SS 304

FA15S6 : 1-1/2" ANSI/ASME B16.5 Flange, SS 316

FA20MS : 2" ANSI/ASME B16.5 Flange, MS Plated

FA20S4 : 2" ANSI/ASME B16.5 Flange, SS 304

FA20S6 : 2" ANSI/ASME B16.5 Flange, SS 316

FA25MS : 2-1/2" ANSI/ASME B16.5 Flange, MS Plated

FA25S4 : 2-1/2" ANSI/ASME B16.5 Flange, SS 304

Mounting
FA25S6 : 2-1/2" ANSI/ASME B16.5 Flange, SS 316
FA30MS : 3" ANSI/ASME B16.5 Flange, MS Plated
FA30S4 : 3" ANSI/ASME B16.5 Flange, SS 304
FA30S6 : 3" ANSI/ASME B16.5 Flange, SS 316
F20MS : 10 mm thick Flange conforming to 2" ANSI/ASME B16.5 Flange, MS Plated
F20S6 : 10 mm thick Flange conforming to 2" ANSI/ASME B16.5 Flange
F25MS : 10 mm thick Flange conforming to 2-1/2" ANSI/ASME B16.5 Flange, MS Plated
F25S4 : 10 mm thick Flange conforming to 2-1/2" ANSI/ASME B16.5 Flange, SS 304
F25S6 : 10 mm thick Flange conforming to 2-1/2" ANSI/ASME B16.5 Flange
F30MS : 10 mm thick Flange conforming to 3" ANSI/ASME B16.5 Flange, MS Plated
F30S4 : 10 mm thick Flange conforming to 3" ANSI/ASME B16.5 Flange, SS 304
F30S6 : 10 mm thick Flange conforming to 3" ANSI/ASME B16.5 Flange
TC10S6 : : 1" Tri-Clamp conforming to ISO 2852
TC15S6 : : 1-1/2" Tri-Clamp conforming to ISO 2852
TC20S6 : : 2" Tri-Clamp conforming to ISO 2852
Insulation Type
P : Part PTFE Insulated
F : Full PTFE Insulated
Sense
SS6 : SS 316
Grounding Length (Optional)
GGI : GI (Galvanized Iron)
GS4 : SS 304
GS6 : SS 316
Operating Temperature
10T : Upto 100°C
25T : Upto 250°C
Standoff Material (Only with "25T")
STGI : GI (Galvanized Iron)
STS4 : SS 304
STS6 : SS 316
Probe Length
1H5H : 100 mm to 1500 mm (Only with 1/2" Mounting)
5H30H : 500 mm to 3000 mm (Only with "Grounding")
1H30H : 100 mm to 3000 mm

31 Product Selection Order Code

Product

CPR : Casper - Microcontroller based Capacitance type Level Limit Switch (Use in Fine Powder, Bulky Solids, Slurries, Liquids etc.)

Type

I : Integral (sensor in same unit)

Indication (Optional)

WL : External LED Indication Infrared Output

Housing

SCUTE : Pressure die-cast aluminium weatherproof (Rating IP68)

FP2C : Cast aluminium weather & flameproof powder coated paint suitable for Gas Group IIC

Probe Housing Cable Entry

PCPG13 : PG 13.5, Polyamide

PCB5D : 1/2" BSP, DC Gland, Brass

PCN5D : 1/2" NPT, DC Gland, Brass

Output

D : 2NO, 2NC DPDT Relay Output (rated at 6 A, 230 V AC for non-inductive load)

SPN : SPDT Relay Output 1NO, 1NC (Relay rated at 6 A, 230 V AC for non-inductive load) and PNP Output (only for supply voltage 18V to 35V DC)

2I : Two Independent SPDT Relay Output Relay1 Relay2 (Rated at 6 A, 230 V AC for non inductive load) at two different Capacitance Set point

2P : 2NO

1P1I : Two SPDT Relay Output (Relay rated at 6 A, 230V AC for non-inductive load)

Relay 1:- Operate on pump control logic

Relay 2:- Operate on Single Independent capacitance set point

Power Supply

U : Universal (18 to 55V DC) and (90 to 265V at 50Hz AC) on same terminals

Reference (Except 1/2", 3/4" Mounting)

REF : Yes (Incase of Non-Metallic Tanks)

STWGI : Still Well

STWS4 : Still Well

STWS6 : Still Well

Probe Type

RDP : Rod Probe

Mounting

MB5S6 : Screwed Thread, BSP 1/2", SS 316

MN5S6 : Screwed Thread, NPT 1/2", SS 316

MB75S6 : Screwed Thread, BSP 3/4", SS 316

MN75S6 : Screwed Thread, NPT 3/4", SS 316

MB10S6 : Screwed Thread, BSP 1", SS 316

MN10S6 : Screwed Thread, NPT 1", SS 316

MB15S4 : Screwed Thread, BSP 1-1/2", SS 304

MB15S6 : Screwed Thread, BSP 1-1/2", SS 316

MN15S4 : Screwed Thread, NPT 1-1/2", SS 304

MN15S6 : Screwed Thread, NPT 1-1/2", SS 316

FA10MS : 1" ANSI/ASME B16.5 Flange, MS Plated

FA10S6 : 1" ANSI/ASME B16.5 Flange, SS 316

Mounting

- FA15MS : 1-1/2" ANSI/ASME B16.5 Flange, MS Plated
- FA15S4 : 1-1/2" ANSI/ASME B16.5 Flange, SS 304
- FA15S6 : 1-1/2" ANSI/ASME B16.5 Flange, SS 316
- FA20MS : 2" ANSI/ASME B16.5 Flange, MS Plated
- FA20S4 : 2" ANSI/ASME B16.5 Flange, SS 304
- FA20S6 : 2" ANSI/ASME B16.5 Flange, SS 316
- FA25MS : 2-1/2" ANSI/ASME B16.5 Flange, MS Plated
- FA25S4 : 2-1/2" ANSI/ASME B16.5 Flange, SS 304
- FA25S6 : 2-1/2" ANSI/ASME B16.5 Flange, SS 316
- FA30MS : 3" ANSI/ASME B16.5 Flange, MS Plated
- FA30S4 : 3" ANSI/ASME B16.5 Flange, SS 304
- FA30S6 : 3" ANSI/ASME B16.5 Flange, SS 316
- F20MS : 10 mm thick Flange conforming to 2" ANSI/ASME B16.5 Flange, MS Plated
- F20S6 : 10 mm thick Flange conforming to 2" ANSI/ASME B16.5 Flange
- F25MS : 10 mm thick Flange conforming to 2-1/2" ANSI/ASME B16.5 Flange, MS Plated
- F25S4 : 10 mm thick Flange conforming to 2-1/2" ANSI/ASME B16.5 Flange, SS 304
- F25S6 : 10 mm thick Flange conforming to 2-1/2" ANSI/ASME B16.5 Flange
- F30MS : 10 mm thick Flange conforming to 3" ANSI/ASME B16.5 Flange, MS Plated
- F30S4 : 10 mm thick Flange conforming to 3" ANSI/ASME B16.5 Flange, SS 304
- F30S6 : 10 mm thick Flange conforming to 3" ANSI/ASME B16.5 Flange
- TC10S6 : : 1" Tri-Clamp conforming to ISO 2852
- TC15S6 : : 1-1/2" Tri-Clamp conforming to ISO 2852
- TC20S6 : : 2" Tri-Clamp conforming to ISO 2852

Insulation Type

- P : Part PTFE Insulated
- F : Full PTFE Insulated

Sense

- SS6 : SS 316

Grounding Length (Optional)

- GGI : GI (Galvanized Iron)
- GS4 : SS 304
- GS6 : SS 316

Operating Temperature

- 10T : Upto 100°C
- 25T : Upto 250°C

Standoff Material (Only with "25T")

- STGI : GI (Galvanized Iron)
- STS4 : SS 304
- STS6 : SS 316

Probe Length

- 1H5H : 100 mm to 1500 mm (Only with 1/2" Mounting)
- 5H30H : 500 mm to 3000 mm (Only with "Grounding")
- 1H30H : 100 mm to 3000 mm