

Grown...to meet challenges

INSTRUCTION MANUAL

CASPER

Capacitance Level Limit Switch

Version 1.0

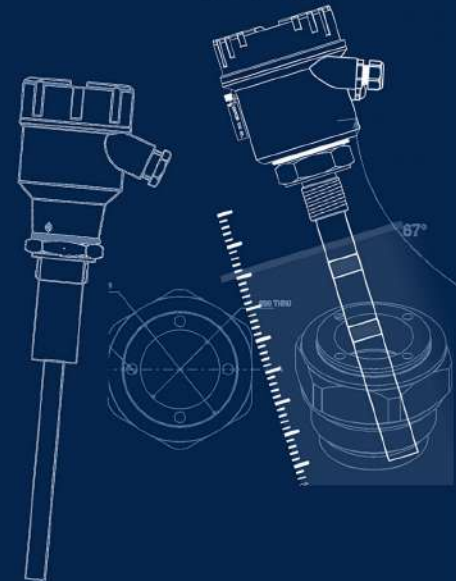
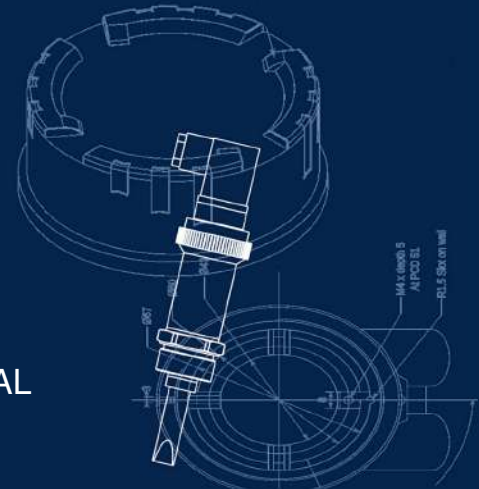

SAPCON INSTRUMENTS PVT. LTD.

30+ Years in Process Control Instrumentation

An ISO 22000 company

www.sapconinstruments.com

Contents

| | |
|--|----|
| Revision History | 5 |
| 1 Introduction | 6 |
| 2 Operating Principle | 6 |
| 3 Features | 6 |
| 4 Applications | 6 |
| 5 Electrical Specifications | 7 |
| 6 Mechanical Specifications | 7 |
| 7 Application Specifications | 8 |
| 8 Installation Guidelines | 8 |
| 9 Electrical Connections | 8 |
| 10 Calibration | 8 |
| 10.1 For Single Point Switching | 8 |
| 10.2 For Two Point / Pump Control Logic | 9 |
| 11 Cover Delay | 9 |
| 11.1 For Single Point / Pump Control Logic | 9 |
| 11.2 For Two Point Switching | 10 |
| 12 Uncover Delay | 11 |
| 12.1 For Single Point / Pump Control Logic | 11 |
| 12.2 Two Point Switching | 11 |
| 13 Sensitivity | 12 |
| 14 Failsafe | 12 |
| 15 Factory Reset | 13 |
| 16 Output Options | 13 |
| 17 Maintenance | 13 |
| 18 Error Indication | 14 |
| 19 Customer Support | 14 |

List of Figures

| | | |
|----|---|----|
| 1 | Casper | 6 |
| 2 | Description of Parts | 6 |
| 3 | Electrical Connections (DPDT) | 8 |
| 4 | Calibration without Material | 9 |
| 5 | Calibration with Material | 9 |
| 6 | Calibration in Two-Point/Pump-Control | 9 |
| 7 | DIP Switch | 10 |
| 8 | Cover Delay Switch Position | 10 |
| 9 | Setting Cover Delay | 10 |
| 10 | Saving Cover Delay | 10 |
| 11 | Cover Delay Switch Position for Relay 2 | 10 |
| 12 | Setting Cover Delay for Relay 2 | 10 |
| 13 | Saving Cover Delay for Relay 2 | 11 |
| 14 | Uncover Delay Switch Position | 11 |
| 15 | Setting Uncover Delay | 11 |
| 16 | Saving Uncover Delay | 11 |
| 17 | Uncover Delay Switch Position for Relay 2 | 12 |
| 18 | Setting Uncover Delay for Relay 2 | 12 |
| 19 | Saving Uncover Delay for Relay 2 | 12 |
| 20 | Switch Position | 12 |
| 21 | Setting Sensitivity | 12 |
| 22 | Setting Sensitivity | 12 |

List of Tables

| | | |
|---|--------------------------------------|----|
| 1 | Electrical Specifications | 7 |
| 2 | Mechanical Specifications | 7 |
| 3 | Application Specifications | 8 |
| 4 | Sensitivity | 13 |
| 5 | Error Indication | 14 |

Revision History

| Revision | Date | Author(s) | Description |
|----------|-------------|-----------|-----------------------|
| 1.0 | 25 Aug 2019 | RND | First Version Editing |

1

1

- **Copyright:** All content on this document, such as text, graphics, logos and images is the property of Sapcon Instruments Pvt. Ltd. The selection, arrangement and presentation of all materials on this document and the overall design of this document is the exclusive property of Sapcon Instruments Pvt. Ltd.
- The images shown in this manual may differ from the actual instrument / housing in terms of dimensions, color and design. Please refer to GA drawings for dimensional details.
- Values (of performance) described in this manual were obtained under ideal testing conditions. Hence, they may differ under industrial environment and settings.

General Instructions

- Instrument shouldn't block the material filling inlet.
- Secure the cover of housing tightly. Tighten the cable glands. For side mounting, the cable glands should point downwards.
- For side mounting, provide a baffle to prevent the material from falling on the probe.
- When handling forks, do not lift them using their tines. While using them with solids, ensure that material size is less than 10mm.
- Deforming the shape of the tines may interfere with the fork's operating frequency.
- Make all electrical connections as instructed in the manual. Don't power on the device before verifying the connections.

1 Introduction

Casper is a microcontroller based capacitance level limit switch. It is suitable for fine, coarse, bulky solids, non-sticky slurries and liquids. The measuring system consists of an electronic insert and a probe. It works by utilizing the dielectric property of the application material.



Figure 1: Casper

2 Operating Principle

Casper works on the principle of capacitance. The probe comprises of a sense electrode, electrically isolated from the metallic tank by means of a suitable insulator. The sense electrode and the vessel wall serve as the two electrodes of a capacitor with the service material acting as the dielectric. A change in the level of material causes a change in the dielectric, which in turn causes the value of this tank capacitor to change.

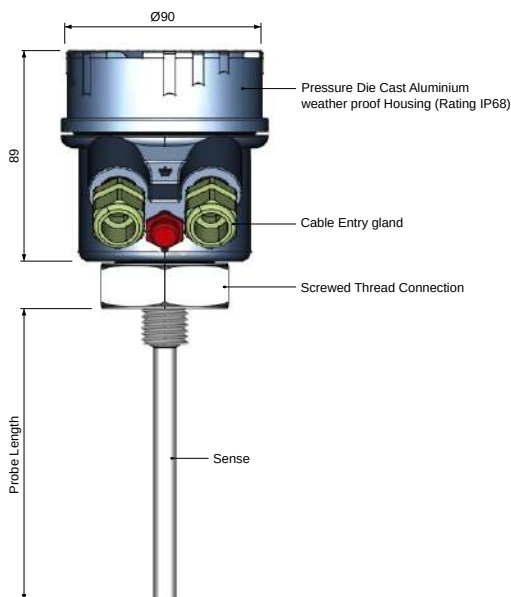

Figure 2: Description of Parts

3 Features

- Universal power supply of 18 - 55 V DC and 90 - 265 V AC on the same terminal.
- customizable probe size.
- Output options: Relay, PNP and Analog.
- High temperature probe suitable for applications up to 250°C.
- Self-diagnosis for probe and electronics.
- Popular with a wide range of materials: low-to-high dielectric conductive materials / non-conductive material.

4 Applications

- Brewery
- Chemicals
- Dairy
- Food and Beverages
- Grain Handling

5 Electrical Specifications

Please refer to Table 1 for Electrical Specifications.

| PARAMETER | VALUE |
|----------------------|--|
| Input Power Supply | 18 - 55V DC and 90 - 265V AC at 50Hz on same terminal |
| Output | <ul style="list-style-type: none"> • Relay SPDT , PNP • Relay DPDT |
| Power Consumption | <ul style="list-style-type: none"> • 1.5W (SPDT, PNP) at 24 V • 2.2W (DPDT) at 24 V |
| Switching | Single-point level switching / Two-point level switching |
| Switching Indication | For Relay 1 and Relay 2 Red - Alarm Green - Normal |
| Fail-safe | Two Field Selectable FS 1 & FS 2 <ul style="list-style-type: none"> • Open - Fail-safe High (For High Level) • Close - Fail-safe Low (For Low Level) |
| Time Delay Setting | 1 - 25 seconds (For both, Covered and Uncovered Delays) |
| Relay Rating | 6 Amps at 230V AC |

Table 1: Electrical Specifications

6 Mechanical Specifications

Please refer to Table 2 for Mechanical Specifications.

| PARAMETER | VALUE |
|-----------------------|---|
| Housing | <ul style="list-style-type: none"> • SCUTE: Pressure die-cast aluminium weatherproof (Rating IP-68) • FP2C: Cast aluminium, weatherproof & flameproof, powder coated, suitable for Gas Groups IIA, IIB & IIC as per IS-2148 |
| Electrical Connector | 2 x 1/2" BSP/NPT , PG 13.5 |
| Operating Temperature | 0°C to 60°C (Electronics) |
| Process Temperature | Up to 250°C |
| Operating Pressure | Up to 10 bar |
| Mounting | <ul style="list-style-type: none"> • Screwed: 1/2", 1", 1 1/2", 3/4" BSP / NPT • Flanged: As per user specification |
| Probe Length | 100 mm to 3000 mm |
| Insulation | Full PTFE |

Table 2: Mechanical Specifications

7 Application Specifications

Please refer to Table 3 for Application Specifications.

| PARAMETER | VALUE |
|---------------|----------|
| Response Time | 1 second |
| Sensitivity | 1 - 5 |

Table 3: Application Specifications

8 Installation Guidelines

While installing the instrument, please take care of the following points:

1. The product should be installed in horizontal or vertical position only in Single Point Switching. Observe that when installed directly under the material inlet source, a canopy called baffle of appropriate strength and size should be welded right above the instrument as shown.
2. In Two Point Switching/ Pump Control Logic, the mounting arrangement should be vertical only.
3. To prevent the ingress of moisture and water seepage in side mounting position, the cable entries should always point downwards.
4. Secure the cover of housing tightly. Tighten the cable glands.
5. Make all electrical connections as instructed in the manual. Don't power on the device before verifying the connections.
6. Weatherproofness of enclosure is guaranteed only if the cover is in place glands adequately tightened. Damage due to accidental entry of water can be avoided if the instrument is installed in a rain shade.
7. If the ambient temperature is high, the instrument should not be installed to receive direct sunlight. In case such a position of shade is not available, a heat shield should be fitted above the instrument especially if the operating temperature lies between 60°C and 80°C.

9 Electrical Connections

Electrical connections for the instrument will change with the models. Please refer to figure 3 and the precautions mentioned below before connecting the device.

Precautions for connecting casper:

- **Power Supply Rating**
Make sure the power supplied to the instrument is within the specified range mentioned in Table 1.

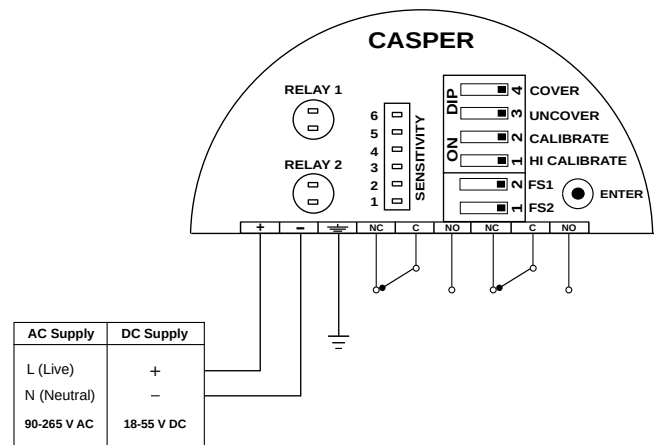

Figure 3: Electrical Connections (DPDT)

- **Connect Earth**
When supplying AC power, please make sure that the grounding screw on the housing and the earth terminal are all connected to the plant's earth.
- **Power Supply Fluctuations & Noise**
External noise or fluctuating power supplies could affect performance and shorten the life of the instrument. Use external line suppressors and fuse wires to contain the risk of damage to the circuit.

10 Calibration

The DIP switches for calibration and settings can be accessed by opening the top aluminium cover. Calibrating the instrument outside the tank can cause malfunctions.

10.1 For Single Point Switching

1. Calibration without material

Note:

Only applicable when there is a non-conductive build-up on the probe.

Calibration should be done without the application material. Once calibrated in the empty tank, the device can be used with a wide range of materials. Casper needs to be calibrated inside the empty process tank (i.e only air, no material). Calibrating the instrument outside the tank can cause malfunctions.

- Make sure that all DIP switches are in the OPEN position.
- Make sure that the status LED is not blinking. A blinking LED here indicates Error.
- To start with the calibration, set the CALIBRATE switch to CLOSE position (CLOSE is opposite of OPEN for DIP switch).

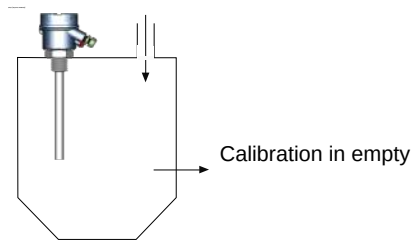

Figure 4: Calibration without Material

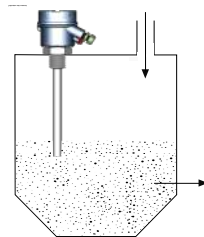

Figure 5: Calibration with Material

- Then press ENTER, the status LED of Relay 1 will blink once in RED color.
- Now set the CALIBRATE switch back to OPEN position.
- Calibration is now completed.

2. Calibration with material

Note:

Only applicable when there is a conductive build-up on the probe.

Casper needs to be calibrated with the application material. Fill the tank with the application material such that the probe is completely covered with the material.

- Make sure that all DIP switches are in the OPEN position.
- Make sure that the status LED is not blinking. A blinking LED here indicates Error.
- To start with the calibration, set the HI CALIBRATE switch to CLOSE position (CLOSE is opposite of OPEN for DIP switch).
- Then press ENTER, the status LED of Relay 1 will blink once in RED color.
- Now set the HI CALIBRATE switch back to OPEN position.
- Calibration is now completed.

10.2 For Two Point / Pump Control Logic

1. **Low Calibration** For Low Calibration, follow the process given below.
 - Make sure that all DIP switches are in the OPEN position.

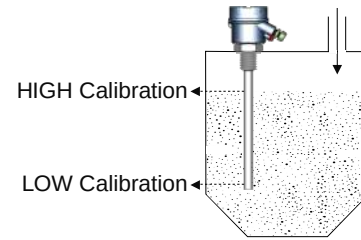

Figure 6: Calibration in Two-Point/Pump-Control

- Make sure that the status LED is not blinking. A blinking LED here indicates Error.
 - To start with the calibration, set the CALIBRATE switch to CLOSE position (CLOSE is opposite of OPEN for DIP switch).
 - Then press ENTER, the status LED of Relay 1 will blink once in RED color.
 - Now set the CALIBRATE switch back to OPEN position.
 - Low calibration is now completed.
2. **High Calibration** For High Calibration, follow the process given below.
 - Make sure that all DIP switches are in the OPEN position.
 - Make sure that the status LED is not blinking. A blinking LED here indicates Error.
 - To start with the calibration, set the HI CALIBRATE switch to CLOSE position (CLOSE is opposite of OPEN for DIP switch).
 - Then press ENTER, the status LED of Relay 1 will blink once in RED color.
 - Now set the HI CALIBRATE switch back to OPEN position.
 - High calibration is now completed.

11 Cover Delay

When the application material covers the probe, the changeover of the output can be delayed by a pre-determined time. This time is called Cover Delay. For a different value of Cover Delay, the number of blinks can be adjusted as per requirement.

Note:

You can set the value of COVER DELAY between 1-25 secs.

11.1 For Single Point / Pump Control Logic

Follow the below procedure for setting Cover Delay

1. Ensure that all DIP switches are in OPEN position as shown in Figure 7. Make sure that STATUS LED is not blinking for Error.

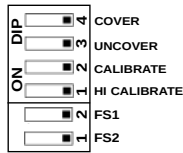

Figure 7: DIP Switch

- To set the Cover Delay, set the COVER switch to CLOSE position as shown in Figure 8. (CLOSE is the opposite of OPEN for a DIP switch.) The STATUS RED LED will glow.

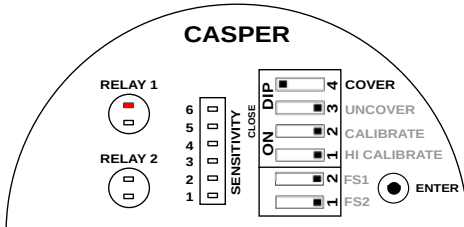

Figure 8: Cover Delay Switch Position

- Press ENTER and keep it pressed as shown in Figure 9. The STATUS RED LED of Relay 1 will start blinking. Count the number of blinks. After setting the value release the ENTER key.

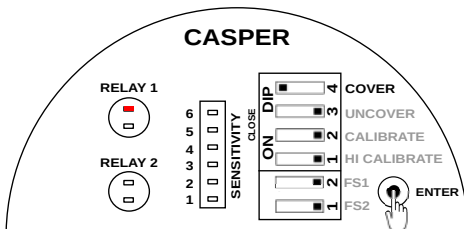

Figure 9: Setting Cover Delay

- Delay is entered, but not saved. To save and test the Cover Delay, set the COVER switch back to OPEN position as shown in Figure 10. The STATUS LED of Relay 1 will come back to its original position.

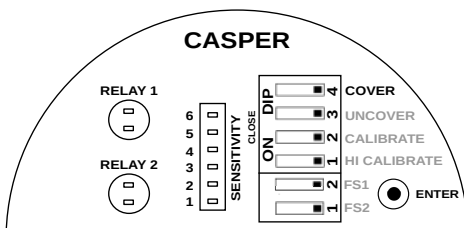

Figure 10: Saving Cover Delay

- To test, dip casper into the application material until the switching point is reached.

The STATUS LED will start blinking RED if the switch point is reached. It will blink for the number of seconds for which the cover delay is set. 1 blink is equal to 1 second during switching. A maximum of 25 seconds can be set.

11.2 For Two Point Switching

Follow the below procedure for setting Cover Delay

- Ensure that all DIP switches are in OPEN position as shown in Figure 7. Make sure that STATUS LED is not blinking for Error.
- To set the Cover Delay for Relay 1, set the COVER switch to CLOSE position as shown in Figure 8. (CLOSE is the opposite of OPEN for a DIP switch.) The STATUS RED LED will glow.
- Press ENTER and keep it pressed as shown in Figure 9. The STATUS RED LED of Relay 1 will start blinking. Count the number of blinks. After setting the value release the ENTER key.
- Delay is entered, but not saved. To save and test the Cover Delay, set the COVER switch back to OPEN position as shown in Figure 10. The STATUS LED of Relay 1 will come back to its original position.
- To set the Cover Delay for Relay 2, set the COVER and HI CALIB switch to CLOSE position as shown in Figure 11.

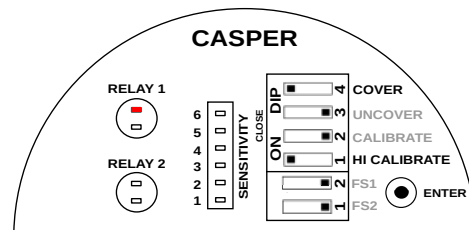

Figure 11: Cover Delay Switch Position for Relay 2

- Press ENTER and keep it pressed as shown in Figure 12. The STATUS RED LED of Relay 1 will start blinking. Count the number of blinks. After setting the value release the ENTER key.

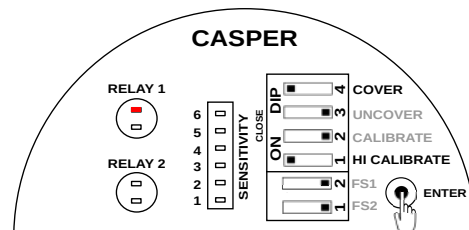

Figure 12: Setting Cover Delay for Relay 2

- Delay is entered, but not saved. To save and test the Cover Delay, set the COVER and HI CALIB switch back to OPEN position as shown in Figure 13. The STATUS LED of Relay 1 will come back to its original position.

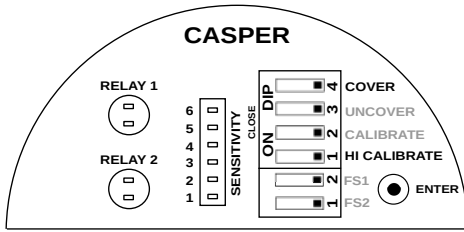

Figure 13: Saving Cover Delay for Relay 2

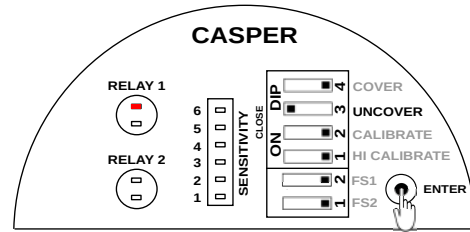

Figure 15: Setting Uncover Delay

- To test, dip casper into the application material until the switching point is reached.

The STATUS LED will start blinking RED if the switch point is reached. It will blink for the number of seconds for which the cover delay is set. 1 blink is equal to 1 second during switching. A maximum of 25 seconds can be set.

12 Uncover Delay

When the application material uncovers casper's probe, the changeover of the output can be delayed by a pre-determined time. This time is called UNCOVER Delay. For a different value of Uncover Delay, the number of blinks can be adjusted as per requirement.

Note:
You can set the value of UNCOVER DELAY between 1-25 secs.

12.1 For Single Point / Pump Control Logic

Follow the below procedure for setting Uncover Delay

- Ensure that all DIP switches are in OPEN position as shown in Figure 7. Make sure that STATUS LED is not blinking for Error.
- To set the Uncover Delay, set the UNCOVER switch to CLOSE position as shown in Figure 14. (CLOSE is the opposite of OPEN for a DIP switch.) The STATUS RED LED will glow.

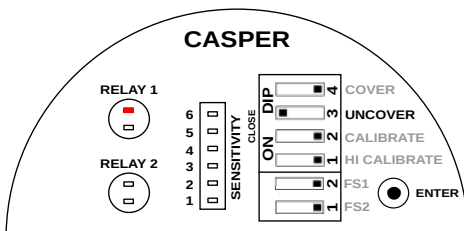

Figure 14: Uncover Delay Switch Position

- Press ENTER and keep it pressed as shown in Figure 15. The STATUS RED LED of Relay 1 will start blinking. Count the number of blinks. After setting the value release the ENTER key.

- Uncover Delay is entered, but not saved. To save and test the Uncover Delay, set the UNCOVER switch back to OPEN position as shown in figure 16. The STATUS LED of Relay 1 will come back to its original position.

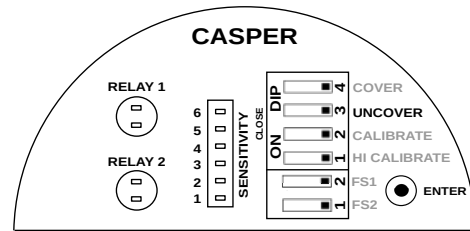

Figure 16: Saving Uncover Delay

- To test, dip casper into the application material until the switching point is achieved.
- The STATUS LED will start blinking GREEN if the switch point is achieved. It will blink for the number of seconds for which the Uncover Delay is set.

12.2 Two Point Switching

Follow the below procedure for setting Uncover Delay

- Ensure that all DIP switches are in OPEN position as shown in Figure 7. Make sure that STATUS LED is not blinking for Error.
- To set the Uncover Delay, set the UNCOVER switch to CLOSE position as shown in Figure 14. (CLOSE is the opposite of OPEN for a DIP switch.) The STATUS RED LED will glow.
- Press ENTER and keep it pressed as shown in Figure 15. The STATUS RED LED of Relay 1 will start blinking. Count the number of blinks. After setting the value release the ENTER key.
- Uncover Delay is entered, but not saved. To save and test the Uncover Delay, set the UNCOVER switch back to OPEN position as shown in figure 16. The STATUS LED of Relay 1 will come back to its original position.
- To set the Uncover Delay for Relay 2, set the UNCOVER and HI CALIB switch to CLOSE position as shown in Figure 17.

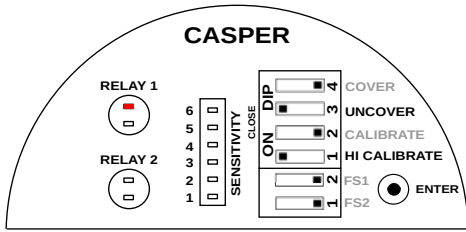

Figure 17: Uncover Delay Switch Position for Relay 2

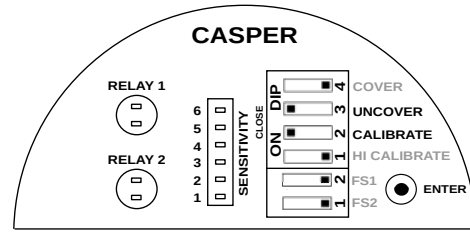

Figure 20: Switch Position

- Press ENTER and keep it pressed as shown in Figure 18. The STATUS RED LED of Relay 1 will start blinking. Count the number of blinks. After setting the value release the ENTER key.

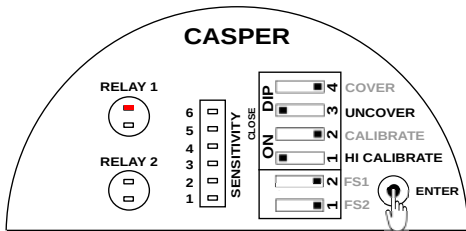

Figure 18: Setting Uncover Delay for Relay 2

- Press ENTER key for number of times according to the sensitivity value.

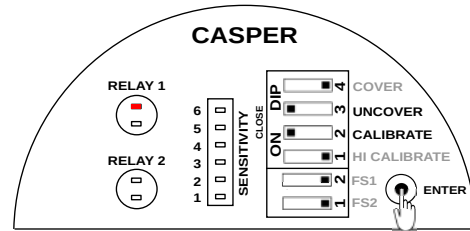

Figure 21: Setting Sensitivity

- Uncover Delay is entered, but not saved. To save and test the Uncover Delay, set the UNCOVER and HI CALIB switch back to OPEN position as shown in figure 19. The STATUS LED of Relay 1 will come back to its original position.

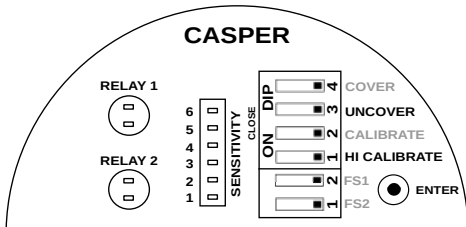

Figure 19: Saving Uncover Delay for Relay 2

- Set the UNCOVER and CALIBRATE switches back to OPEN position.

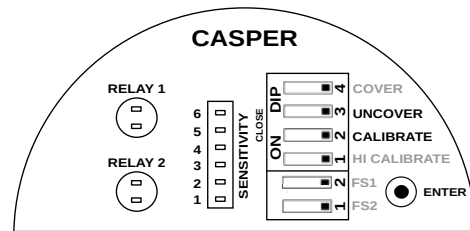

Figure 22: Setting Sensitivity

- To test, dip casper into the application material until the switching point is achieved.
- The STATUS LED will start blinking GREEN if the switch point is achieved. It will blink for the number of seconds for which the Uncover Delay is set.

- Check operation of casper by filling in and draining out the material.
- If the instrument does not switch when covered fully with the material, try again with a higher value of sensitivity.
- If the instrument switches when covered fully with the material, but does not switch back to normal state when uncovered, try again with a lower sensitivity value.

Please refer to Table 4 before selecting sensitivity value.

13 Sensitivity

The instrument has 5-point sensitivity level to suit a wide range of application materials. By default, the sensitivity is set to 3 to suit a wide range of materials. Traverse the following steps to set the sensitivity of casper.

- Set the UNCOVER and CALIBRATE switch to CLOSE position.

14 Failsafe

In a condition of device failure, known errors and input power failure the outputs of the device resemble the ALARM condition. This is meant to prevent overflow or dry run conditions in case of failures.

Prevent Overflow - High Level Switch Failsafe High (default) is set by moving the FS 1 and FS 2 switch for relay 1 and 2 to OPEN position.

| SENSITIVITY | DIELECTRIC CONSTANT |
|-------------|---------------------|
| 1 | > 30 |
| 2 | 20-30 |
| 3 | 5-20 |
| 4 | 2-5 |
| 5 | > 1.5 & < 2 |

Table 4: Sensitivity

1. When not in contact with the material, LED turns GREEN.
2. When in contact with the material, LED turns RED.

Prevent Dry run - Low Level Switch Failsafe Low is set by moving the FS 1 and FS 2 switch for relay 1 and 2 switch to CLOSE position.

1. When in contact with the material, LED turns GREEN.
2. When not in contact with the material, LED turns RED.

15 Factory Reset

To reset time delays and sensitivity values to default values, follow the following steps:

1. Set the CALIBRATE, COVER and UNCOVER switches to CLOSE position
2. PRESS and HOLD the ENTER key until the status LED of Relay 1 blinks.
3. Switch the LOW CALIB, COVER and UNCOVER switches back to OPEN position.
4. This will set the time delay to 0 and the sensitivity level to 3.

16 Output Options

Casper can be configured into three modes as per requirement which are as follows.

1. Single Point Switching
2. Two Point Switching
3. Pump Control Logic

Note: While changing the configuration mode the value of Time Delay and Sensitivity will be changed to default value.

Follow the procedure for setting Single Point or Two Point Switching

- Set the COVER and UNCOVER switch to CLOSE position.

- Press ENTER Key.
- The STATUS LED of RELAY 1 starts blinking. Count the number of blinks.
- For setting **Single Point Switching** release the ENTER key after 1 blink.
- For setting **Two Point Switching** release the ENTER key after 2 blinks.

Follow the procedure for setting Pump Control Logic

- Set the COVER and CALIBRATE switch to CLOSE position.
- Press ENTER Key.
- The STATUS LED of RELAY 1 starts blinking. Count the number of blinks.
- Release the Enter key after 1 blink will **ON** the **Pump Control**.
- Releasing the Enter Key after 2 blinks will **OFF** the **Pump Control**.

For user point of view, a new feature is developed by which user can be able to identify that on which mode the instrument is being operated. To see the configuration mode press ENTER.

- If 1st LED is ON in DOT Display Bar then the instrument is operated at Single Point Switching without material.
- If 2nd LED is ON in DOT Display Bar then the instrument is operated at Single Point Switching with material.
- If 3rd LED is ON in DOT Display Bar then the instrument is operated at Two Point Switching.
- If 4th LED is ON in DOT Display Bar then the instrument is operated at Pump Control Logic.

17 Maintenance

The electronics of this instrument needs no maintenance. When cleaning and checking the vessel, free the probe from deposits. If the material has a tendency to form a hard sticky deposit, then the instrument must be checked more often. Make sure that the cable ducts and the lid are tightly sealed so that no moisture seeps into the instrument.

18 Error Indication

On error, the status LED starts blinking RED and GREEN alternately at a faster rate. Normal LED blinks are always at the rate of 1 blink per second, in either RED or GREEN color. In some cases, a GREEN or a RED blinking could indicate an error. Refer to Table 5 for a list of errors and their indication.

| LED ERROR INDICATION | DESCRIPTION | TROUBLESHOOTING |
|--|-------------------------|---|
| RED-GREEN Blinking | Calibration Error | Recalibrate the instrument, make sure that the probe is calibrated in an empty metal-body tank. |
| RED Blinking | Probe Short-Circuit | Moisture deposition in the probe connector. Clean the connector and use the instrument. |
| GREEN Blinking | Probe Open | Remove the electronic insert from the housing and check the cable connections of the probe. |
| 3 Times GREEN Blinking and 1 Red Blink | Illegal Key Combination | Switch all DIP switches to open position. Use only legal combination of keys. |
| 3 Times RED Blinking and 1 GREEN Blink | Circuit Error | Contact the Customer Support department at Sapcon. |

Table 5: Error Indication

19 Customer Support

Thank you for going through the instructions given in this manual. To further ease the process of installation and use, we have developed special demo videos which are hosted on YouTube.

Sapcon's YouTube channel, SAPCON INSTRUMENTS, lists all these videos: <https://goo.gl/dnxfzc>

Should you require further information regarding installation, use or working of the instrument, please don't hesitate to contact us. Kindly provide the following information at the time of contacting:

- Instrument Model and Serial Number
- Purchase Order Number and Date of Purchase
- Description of the query
- Your contact details

In an attempt to serve you better, we are open seven days a week (9:30am to 7:30pm). We are available at:

- www.sapconinstruments.com
- sales@sapcon.in
- +91-731-4757575